

Dual N-channel MOSFET (common drain)

ELM18810BA-S

<http://www.elm-tech.com>

■ General description

ELM18810BA-S uses advanced trench technology to provide excellent $R_{ds(on)}$, low gate charge and operation with gate voltages as low as 1.8V and internal ESD protection.

■ Features

- $V_{ds}=20V$
- $I_d=7A$ ($V_{gs}=4.5V$)
- $R_{ds(on)} < 20m\Omega$ ($V_{gs}=4.5V$)
- $R_{ds(on)} < 24m\Omega$ ($V_{gs}=2.5V$)
- $R_{ds(on)} < 32m\Omega$ ($V_{gs}=1.8V$)
- ESD Rating : 2000V HBM

■ Maximum absolute ratings

$T_a=25^\circ C$. Unless otherwise noted.

Parameter	Symbol	Limit	Unit	Note	
Drain-source voltage	V_{ds}	20	V		
Gate-source voltage	V_{gs}	± 8	V		
Continuous drain current	I_d	$T_a=25^\circ C$	7.0	A	1
		$T_a=70^\circ C$	5.7		
Pulsed drain current	I_{dm}	30	A	2	
Power dissipation	P_d	$T_c=25^\circ C$	1.5	W	1
		$T_c=70^\circ C$	1.0		
Junction and storage temperature range	T_j, T_{stg}	-55 to 150	$^\circ C$		

■ Thermal characteristics

Parameter	Symbol	Typ.	Max.	Unit	Note
Thermal resistance junction-to-ambient	$R_{\theta ja}$	$t \leq 10s$	64	$^\circ C/W$	1
Thermal resistance junction-to-ambient		Steady-state	89	$^\circ C/W$	
Thermal resistance junction-to-lead	$R_{\theta jl}$	Steady-state	53	$^\circ C/W$	3

■ Pin configuration

TSSOP-8(TOP VIEW)



Pin No.	Pin name
1	DRAIN1/DRAIN2
2	SOURCE1
3	SOURCE1
4	GATE1
5	GATE2
6	SOURCE2
7	SOURCE2
8	DRAIN1/DRAIN2

■ Circuit

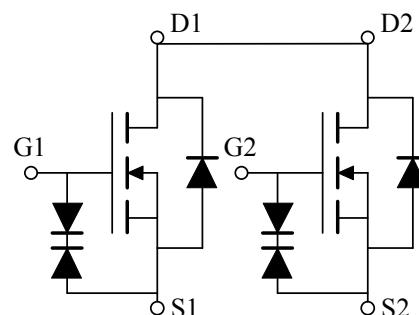

Dual N-channel MOSFET (common drain)

ELM18810BA-S

<http://www.elm-tech.com>

■ Electrical characteristics

Ta=25°C. Unless otherwise noted.

Parameter	Symbol	Condition	Min.	Typ.	Max.	Unit
STATIC PARAMETERS						
Drain-source breakdown voltage	BVdss	Id=250μA, Vgs=0V	20			V
Zero gate voltage drain current	Idss	Vds=16V, Vgs=0V Ta=55°C			1	μA
					5	
Gate-body leakage current	Igss	Vds=0V, Vgs=±4.5V			±1	μA
		Vds=0V, Vgs=±8V			±10	μA
Gate threshold voltage	Vgs(th)	Vds=Vgs, Id=250μA	0.4	0.6	1.0	V
On state drain current	Id(on)	Vgs=4.5V, Vds=5V	30			A
Static drain-source on-resistance	Rds(on)	Vgs=4.5V, Id=7A Ta=125°C		16.5	20.0	mΩ
				23.0	28.0	
		Vgs=2.5V, Id=5.5A		20.0	24.0	
		Vgs=1.8V, Id=5A		24.0	32.0	
Forward transconductance	Gfs	Vds=5V, Id=7A		29		S
Diode forward voltage	Vsd	Is=1A, Vgs=0V		0.76	1.00	V
Max. body-diode continuous current	Is				2.5	A
DYNAMIC PARAMETERS						
Input capacitance	Ciss			1160		pF
Output capacitance	Coss	Vgs=0V, Vds=10V, f=1MHz		187		pF
Reverse transfer capacitance	Crss			146		pF
Gate resistance	Rg	Vgs=0V, Vds=0V, f=1MHz		1.5		Ω
SWITCHING PARAMETERS						
Total gate charge	Qg			16.0		nC
Gate-source charge	Qgs	Vgs=4.5V, Vds=10V, Id=7A		0.8		nC
Gate-drain charge	Qgd			3.8		nC
Turn-on delay time	td(on)			6.2		ns
Turn-on rise time	tr	Vgs=5V, Vds=10V		12.7		ns
Turn-off delay time	td(off)	RL=1.35Ω, Rgen=3Ω		51.7		ns
Turn-off fall time	tf			16.0		ns
Body diode reverse recovery time	trr	If=7A, dIf/dt=100A/μs		17.7		ns
Body diode reverse recovery charge	Qrr	If=7A, dIf/dt=100A/μs		6.7		nC

NOTE :

1. The value of Rθja is measured with the device mounted on 1in² FR-4 board of 2oz. Copper, in still air environment with Ta=25°C. The value in any given applications depends on the user's specific board design, The current rating is based on the t ≤ 10s thermal resistance rating.
2. Repetitive rating, pulse width limited by junction temperature.
3. The Rθja is the sum of the thermal impedance from junction to lead Rθjl and lead to ambient.
4. The static characteristics in Figures 1 to 6 are obtained using 80μs pulses, duty cycle 0.5%max.
5. These tests are performed with the device mounted on 1in² FR-4 board with 2oz. Copper, in a still air environment with Ta=25°C. The SOA curve provides a single pulse rating.

Dual N-channel MOSFET (common drain)

ELM18810BA-S

<http://www.elm-tech.com>

Typical electrical and thermal characteristics

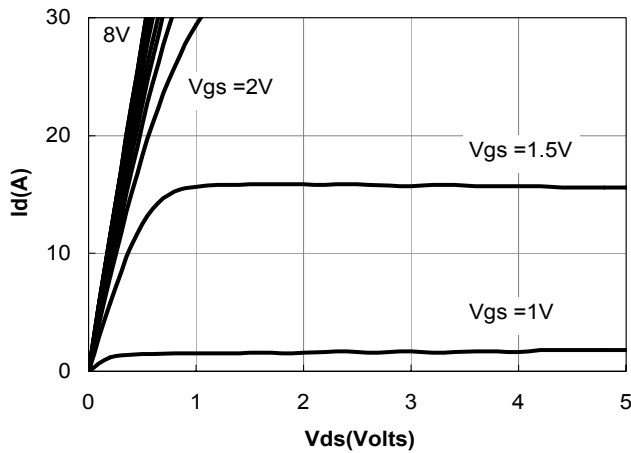

Figure 1: On-Regions Characteristic CS

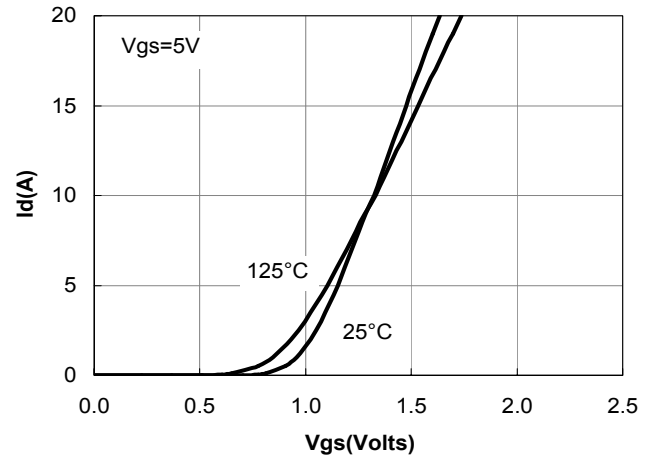

Figure 2: Transfer Characteristics

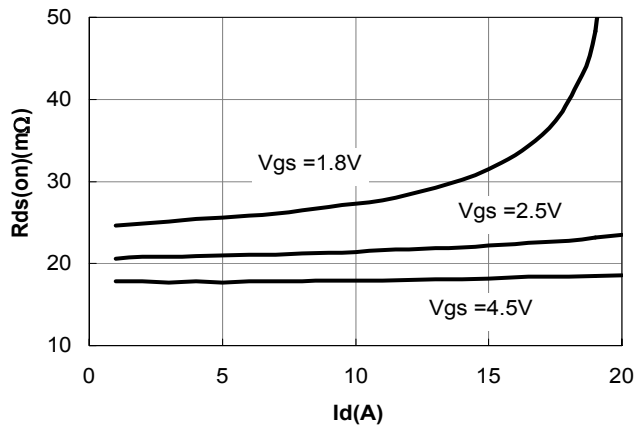

Figure 3: On-Resistance vs. Drain Current and Gate Voltage

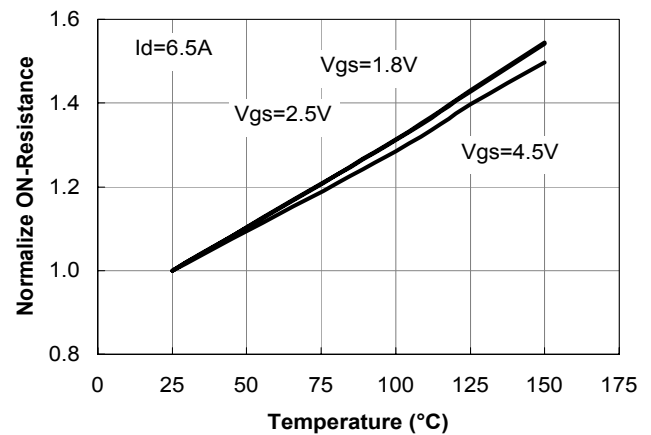

Figure 4: On-Resistance vs. Junction Temperature

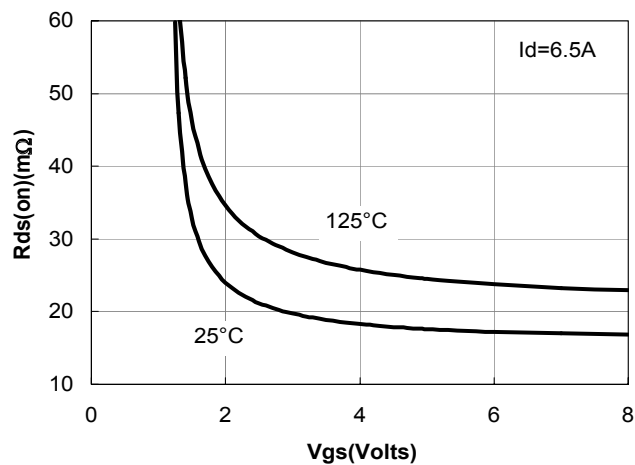

Figure 5: On-Resistance vs. Gate-Source Voltage

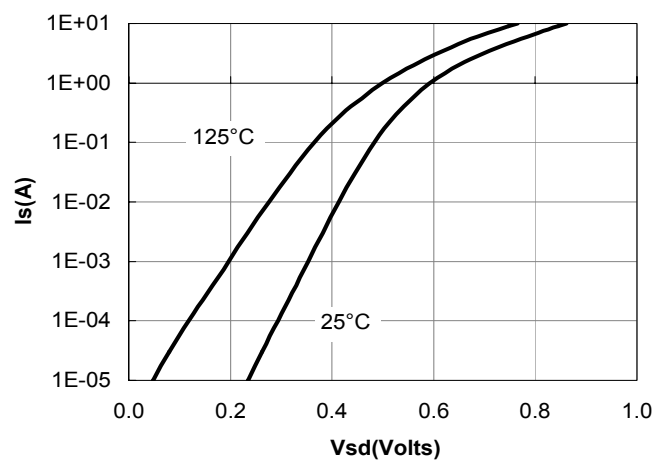

Figure 6: Body-Diode Characteristics

Dual N-channel MOSFET (common drain)

ELM18810BA-S

<http://www.elm-tech.com>

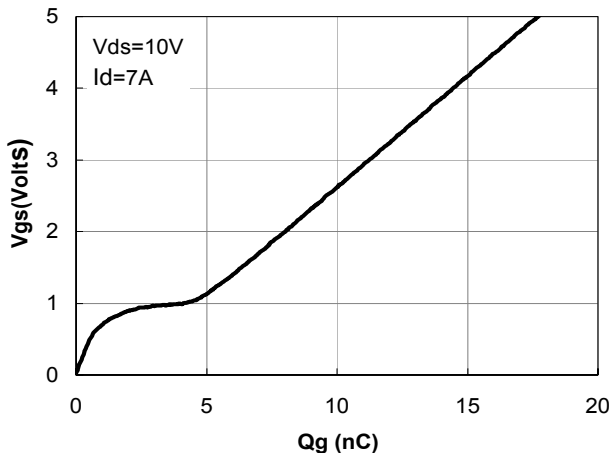

Figure 7: Gate-Charge Characteristics

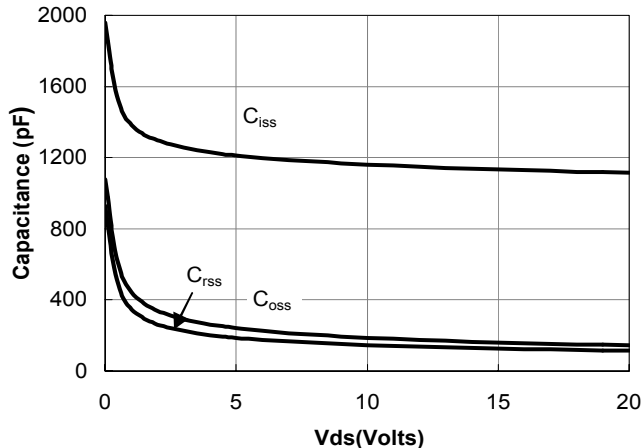

Figure 8: Capacitance Characteristics

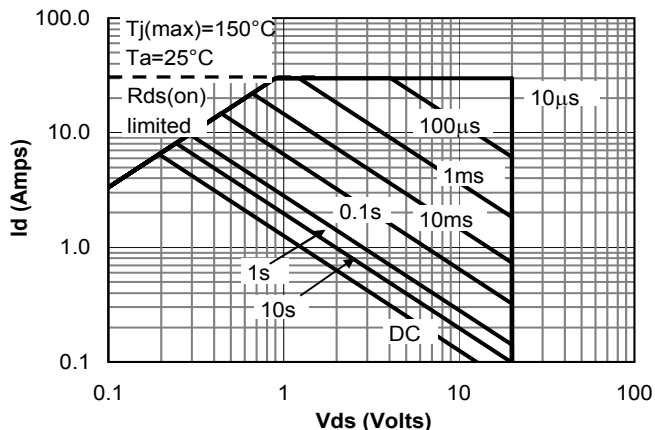

Figure 9: Maximum Forward Biased Safe Operating Area (Note 5)

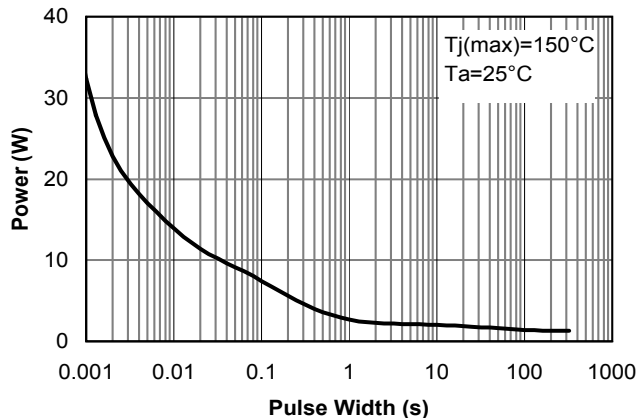

Figure 10: Single Pulse Power Rating Junction-to-Ambient (Note 5)

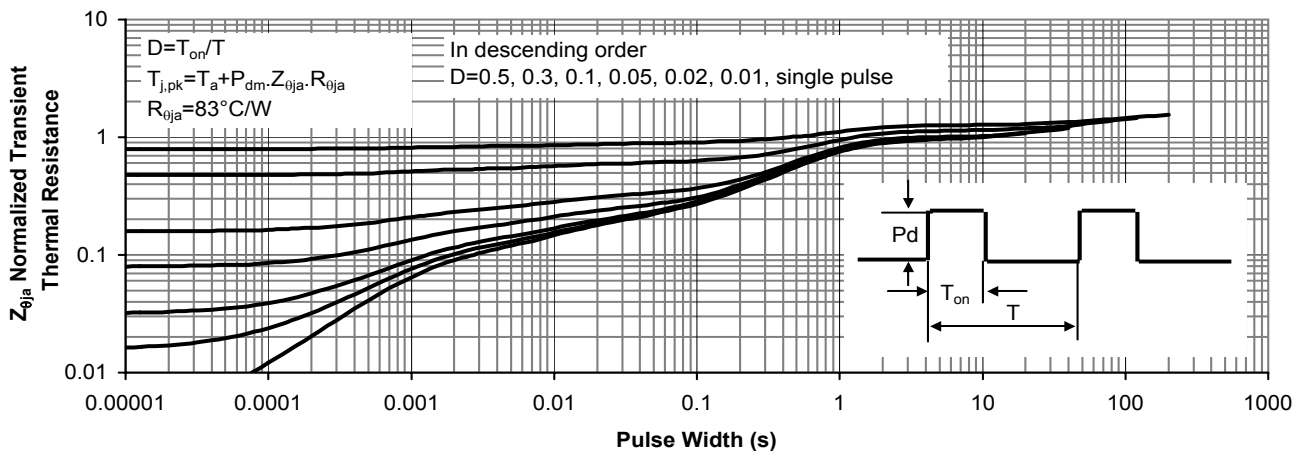

Figure 11: Normalized Maximum Transient Thermal Impedance