

Single P-channel MOSFET

ELM51013A-S

<http://www.elm-tech.com>

■ General description

ELM51013A-S uses advanced trench technology to provide excellent $R_{ds(on)}$, low gate charge and low gate threshold voltage.

■ Features

- $V_{ds} = -20V$
- $I_d = -0.7A$
- $R_{ds(on)} = 620m\Omega$ ($V_{gs} = -4.5V$)
- $R_{ds(on)} = 860m\Omega$ ($V_{gs} = -2.5V$)
- $R_{ds(on)} = 1450m\Omega$ ($V_{gs} = -1.8V$)

■ Maximum absolute ratings

$T_a = 25^\circ C$. Unless otherwise noted.

Parameter	Symbol	Limit	Unit	
Drain-source voltage	V_{ds}	-20	V	
Gate-source voltage	V_{gs}	± 12	V	
Continuous drain current ($T_j = 150^\circ C$)	I_d	$T_a = 25^\circ C$	-0.7	A
		$T_a = 70^\circ C$	-0.4	
Pulsed drain current	I_{dm}	-1.0	A	
Power dissipation	P_d	$T_c = 25^\circ C$	0.27	W
		$T_c = 70^\circ C$	0.16	
Junction and storage temperature range	T_j, T_{stg}	- 55 to 150	$^\circ C$	

■ Pin configuration

SOT-523(TOP VIEW)

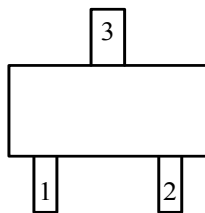

Pin No.	Pin name
1	GATE
2	SOURCE
3	DRAIN

■ Circuit

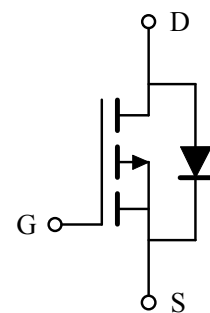

Single P-channel MOSFET

ELM51013A-S

<http://www.elm-tech.com>

■Electrical characteristics

Ta=25°C. Unless otherwise noted.

Parameter	Symbol	Condition	Min.	Typ.	Max.	Unit
STATIC PARAMETERS						
Drain-source breakdown voltage	BVdss	Vgs=0V, Id=-250μA	-20			V
Zero gate voltage drain current	Idss	Vds=-20V, Vgs=0V			-1	μA
		Vds=-20V, Vgs=0V, Ta=85°C			-5	
Gate-body leakage current	Igss	Vds=0V, Vgs=±12V			±100	nA
Gate threshold voltage	Vgs(th)	Vds=Vgs, Id=-250μA	-0.4		-1.0	V
On state drain current	Id(on)	Vgs=-4.5V, Vds≥-5V	-0.7			A
Static drain-source on-resistance	Rds(on)	Vgs=-4.5V, Id=-0.6A		500	620	mΩ
		Vgs=-2.5V, Id=-0.5A		700	860	
		Vgs=-1.8V, Id=-0.4A		1000	1450	
Forward transconductance	Gfs	Vds=-10V, Id=-0.4A		1		S
Diode forward voltage	Vsd	Is=-0.15A, Vgs=0V		-0.65	-1.20	V
Max. body-diode continuous current	Is				-0.3	A
DYNAMIC PARAMETERS						
Input capacitance	Ciss	Vgs=0V, Vds=-10V, f=1MHz		70	100	pF
Output capacitance	Coss			20		pF
Reverse transfer capacitance	Crss			10		pF
SWITCHING PARAMETERS						
Total gate charge	Qg	Vgs=-4.5V, Vds=-10V Id=-0.25A		1.0	1.3	nC
Gate-source charge	Qgs			0.1		nC
Gate-drain charge	Qgd			0.3		nC
Turn-on delay time	td(on)	Vgs=-4.5V, Vds=-10V RL=30Ω, Id=-0.2A Rgen=10Ω		10	15	ns
Turn-on rise time	tr			10	15	ns
Turn-off delay time	td(off)			40	60	ns
Turn-off fall time	tf			30	50	ns

Single P-channel MOSFET

ELM51013A-S

<http://www.elm-tech.com>

Typical electrical and thermal characteristics

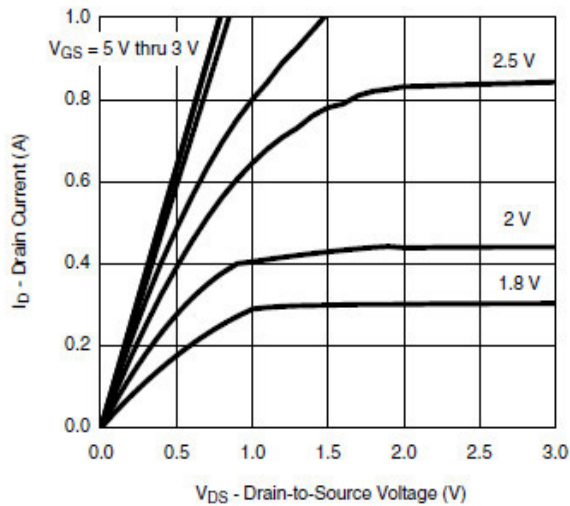

Output Characteristics

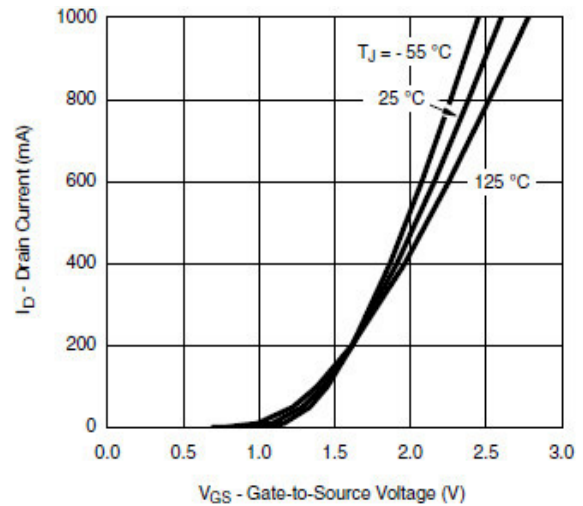

Transfer Characteristics

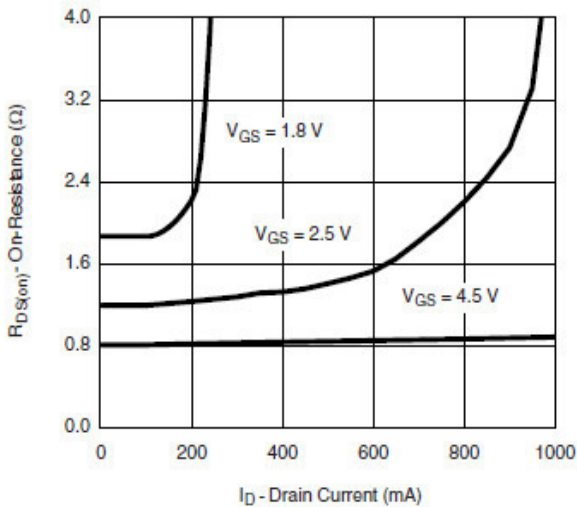

On-Resistance vs. Drain Current

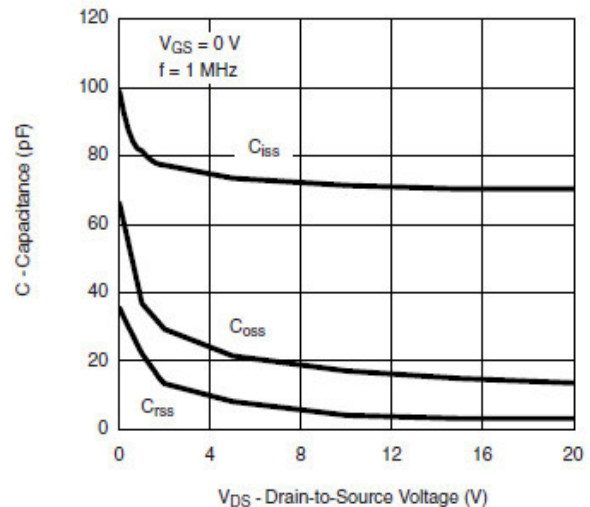

Capacitance

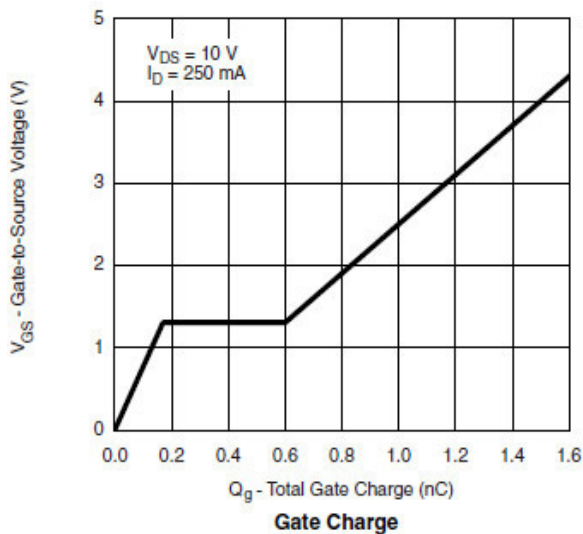

Gate Charge

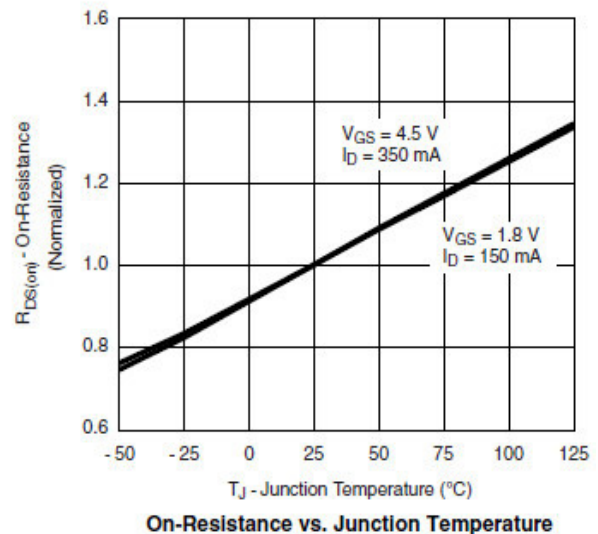

On-Resistance vs. Junction Temperature

Single P-channel MOSFET

ELM51013A-S

<http://www.elm-tech.com>

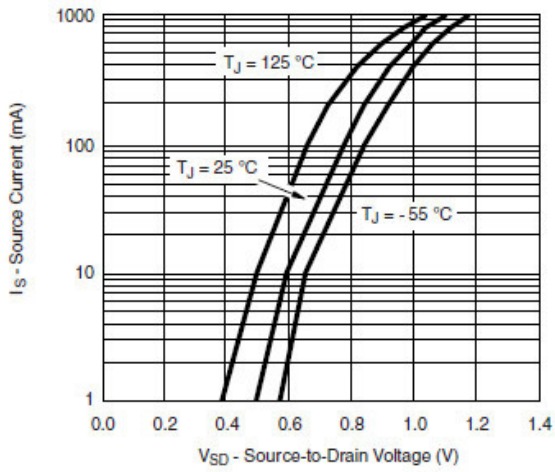

Source-Drain Diode Forward Voltage

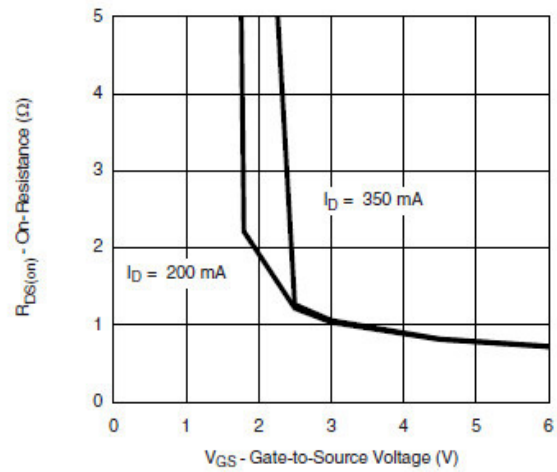

On-Resistance vs. Gate-to-Source Voltage

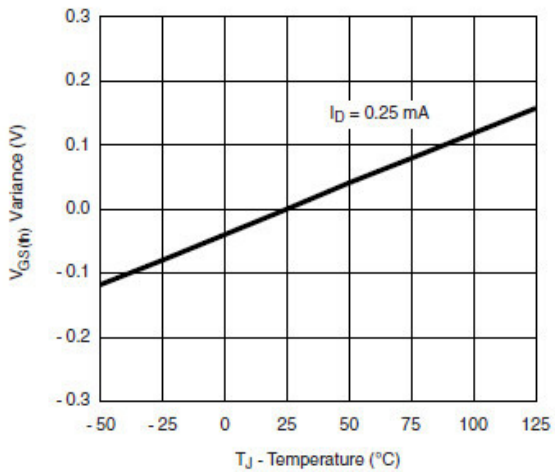

Threshold Voltage Variance vs. Temperature

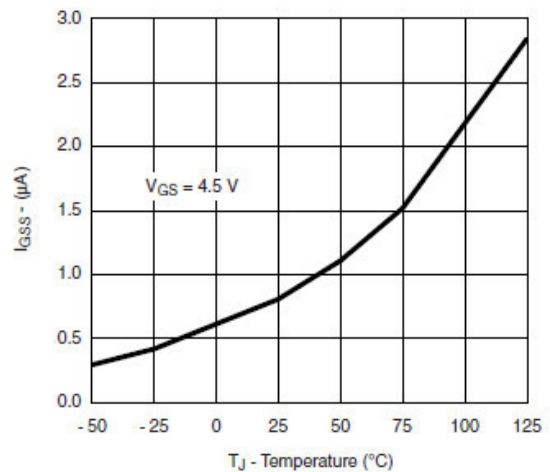

I_{GSS} vs. Temperature

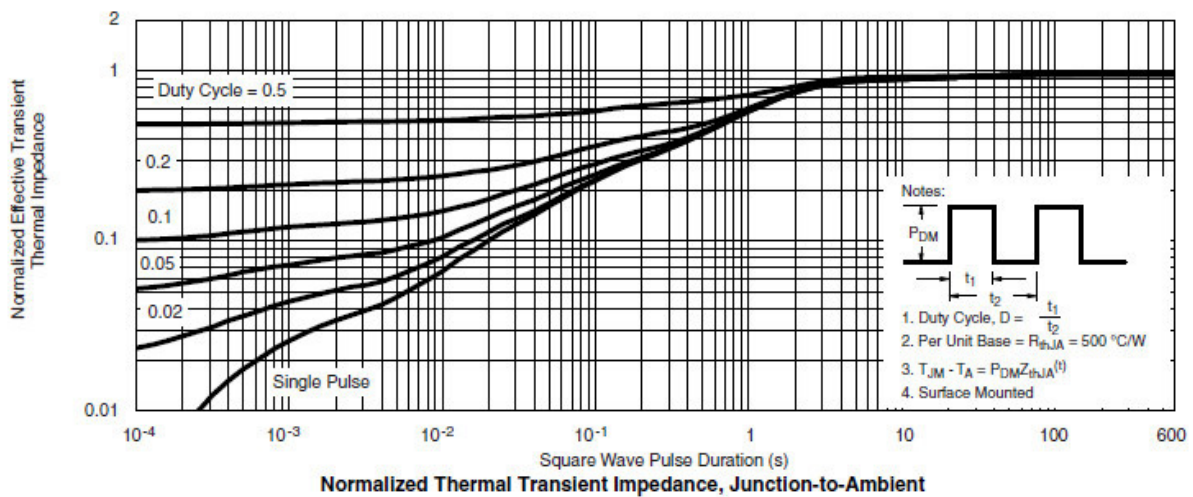

Normalized Thermal Transient Impedance, Junction-to-Ambient

Single P-channel MOSFET

ELM51013A-S

<http://www.elm-tech.com>

■ Test circuit and waveform

Gate Charge Test Circuit & Waveform

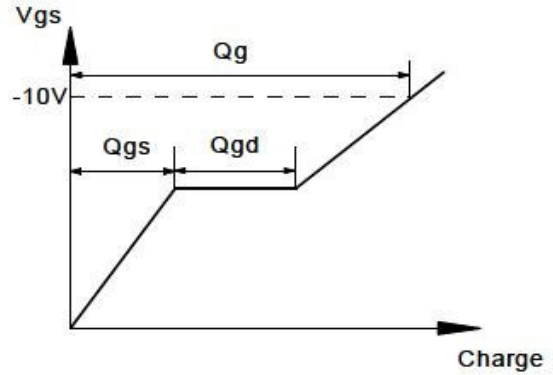
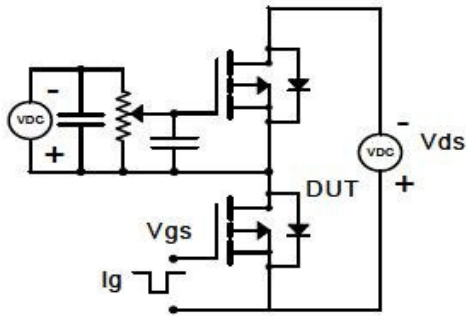

Resistive Switching Test Circuit & Waveforms

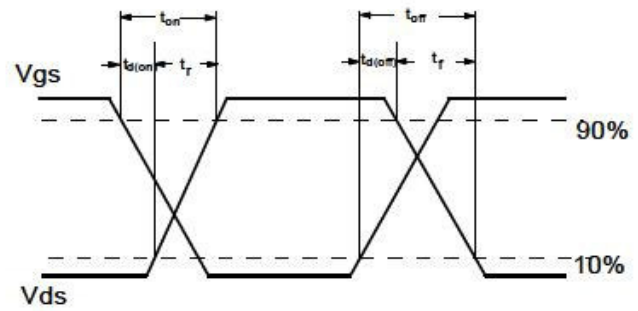
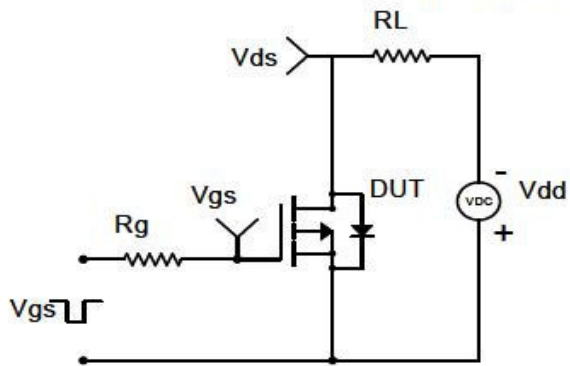

Diode Recovery Test Circuit & Waveforms

