

ELM852xA 150µA Low power CMOS operational amplifier

<http://www.elm-tech.com>

■ General description

ELM852xA is a low current consumption-Typ.150µA CMOS OP-AMP provided with a wide common mode input voltage range. It has a quasi rail-to-rail input stage and a push-pull rail-to-rail output stage. ELM852xA can operate down to 1.2V. ELM852xA is suitable for portable devices which require low power and a single voltage source.

■ Features

- Operation from a single power source
- Low voltage operation : $1.2V \leq V_{dd} \leq 6.0V$
- Low current consumption : Typ.150µA($V_{dd}=3.0V$)
- N-channel depletion differential input
 - : No gm dependence on input operating points
- Common-mode input voltage range
 - : Quasi rail-to-rail input
 - V_{ss} to $V_{dd}-0.3V$ ($V_{dd}=1.5V$)
 - V_{ss} to $V_{dd}-0.1V$ ($V_{dd}=3.0V$)
- Output stage : Push-pull rail-to-rail output
- Unity gain bandwidth : Typ.15kHz($V_{dd} \geq 1.5V$)
- Package : SOT-25, SC-70-5(SOT-353)

■ Application

- Battery-operated portable devices
- Micropower signal process
- Low voltage analog circuit

■ Maximum absolute ratings

Parameter	Symbol	Limit	Unit
Power supply voltage	V _{dd}	7.0	V
Input voltage	V _{in}	V _{ss} -0.3 to V _{dd} +0.3	V
Output voltage	V _{out}	V _{ss} -0.3 to V _{dd} +0.3	V
Output short circuit		Continuous	Sec.
Power dissipation	P _d	300 (SOT-25)	mW
		150 (SC-70-5(SOT-353))	
Operating temperature	T _{op}	-40 to +85	°C
Storage temperature	T _{stg}	-55 to +125	°C

■ Selection guide

ELM852xA-x

Symbol		
a	Package	B: SOT-25 C: SC-70-5(SOT-353)
b	Product version	A
c	Taping direction	S: Refer to PKG file N: Refer to PKG file

ELM852 x A - x
 ↑ ↑ ↑
 a b c

ELM852xA 150µA Low power CMOS operational amplifier

<http://www.elm-tech.com>

■ Pin configuration

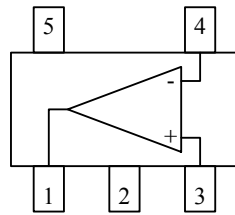

Pin No.	Pin name
1	OUT
2	VDD
3	IN+
4	IN-
5	VSS

■ Standard circuit

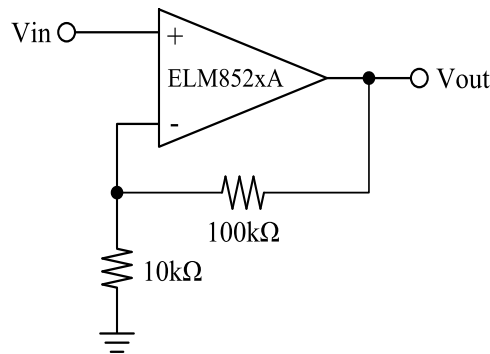

■ Marking

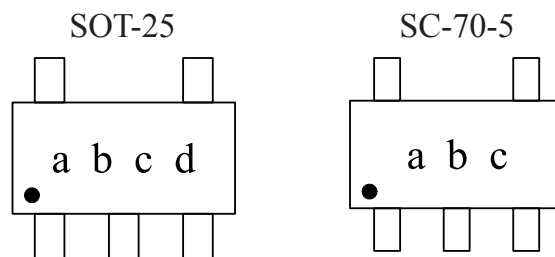

Symbol	Mark	Content
a, b	5 D	ELM852BA (SOT-25)
	> 3	ELM852CA (SC-70-5)
c	0 to 9 and A to Z (I, O, X excepted.)	Lot No.
d	0 to 9 and A to Z (I, O, X excepted.)	Lot No.

ELM852xA 150 μ A Low power CMOS operational amplifier

<http://www.elm-tech.com>

■ Electrical characteristics

V_{ss}=0V, Top=-40~+85°C

Parameter	Symbol	Condition	Min.	Typ.	Max.	Unit
Operating voltage	V _{dd}		1.2		6.0	V

V_{dd}=1.5V

V_{ss}=0V, Top=25°C

Parameter	Symbol	Condition	Min.	Typ.	Max.	Unit
Input offset voltage	V _{io}	V _{cm} =V _{dd} /2, Unity gain follower			±6	mV
Input bias current	I _{ib}				1.0	nA
Common-mode input voltage range	V _{cmr}	For CMRR \geq 45dB	0.00		1.20	V
Maximum output voltage swing	V _{outsh}	V _{id} =100mV, R _L =10k Ω to V _{ss}	1.40			V
Minimum output voltage swing	V _{outsl}	V _{id} =100mV, R _L =10k Ω to V _{dd}			0.10	V
Source current	I _{source}	V _{out} =1.2V, V _{id} =100mV	0.4	1.0		mA
Sink current	I _{sink}	V _{out} =0.3V, V _{id} =100mV	1.0	2.5		mA
Large-signal voltage gain	A _{vd}	R _L =10k Ω to V _{ss} , V _{cm} =0.75V		115		dB
Common-mode rejection ratio	CMRR	R _L =100k Ω to V _{ss} , V _{cm} =0.75V		95		dB
Supply voltage rejection ratio	PSRR	R _L =100k Ω to V _{ss} , V _{cm} =0.75V		90		dB
Current consumption	I _{ss}	V _{cm} =V _{dd} /2, Unity gain follower		140	280	μ A
Short current	I _{shortp}	V _{out} to V _{ss} shrot, V _{id} =100mV		1.4		mA
	I _{shortn}	V _{out} to V _{dd} shrot, V _{id} =100mV		4.0		mA
Unity gain bandwidth	GBW			1		MHz
Slew rate	SR	R _L =100k Ω , C _L =20pF	0.55	1.00		V/ μ s

V_{dd}=3.0V

V_{ss}=0V, Top=25°C

Parameter	Symbol	Condition	Min.	Typ.	Max.	Unit
Input offset voltage	V _{io}	V _{cm} =V _{dd} /2, Unity gain follower			±6	mV
Input bias current	I _{ib}				1.0	nA
Common-mode input voltage range	V _{cmr}	For CMRR \geq 45dB	0.00		2.90	V
Maximum output voltage swing	V _{outsh}	V _{id} =100mV, R _L =10k Ω to V _{ss}	2.90			V
Minimum output voltage swing	V _{outsl}	V _{id} =100mV, R _L =10k Ω to V _{dd}			0.10	V
Source current	I _{source}	V _{out} =2.7V, V _{id} =100mV	1.5	4.0		mA
Sink current	I _{sink}	V _{out} =0.3V, V _{id} =100mV	3.0	7.5		mA
Large-signal voltage gain	A _{vd}	R _L =10k Ω to V _{ss} , V _{cm} =1.5V		120		dB
Common-mode rejection ratio	CMRR	R _L =10k Ω to V _{ss} , V _{cm} =1.5V		85		dB
Supply voltage rejection ratio	PSRR	R _L =10k Ω to V _{ss} , V _{cm} =1.5V		100		dB
Current consumption	I _{ss}	V _{cm} =V _{dd} /2, Unity gain follower		150	300	μ A
Short current	I _{shortp}	V _{out} to V _{ss} shrot, V _{id} =100mV		14		mA
	I _{shortn}	V _{out} to V _{dd} shrot, V _{id} =100mV		25		mA
Unity gain bandwidth	GBW			1		MHz
Slew rate	SR	R _L =100k Ω , C _L =20pF	0.40	1.00		V/ μ s

ELM852xA 150 μ A Low power CMOS operational amplifier

<http://www.elm-tech.com>

■Note

1) Common mode input voltage range

ELM852xA common mode input voltage range is fixed under the condition of $CMRR \geq 45\text{dB}$; ELM852xA is able to accept the input above its specification if the degradation of $CMRR$ is not considered. Even if the input voltage exceeds either positive or negative power voltage, troubles such as reverse of output will not occur.

As maximum absolute rating, the input voltage is possible within $(V_{ss}-0.3)\text{V}$ to $(V_{dd}+0.3)\text{V}$.

2) Operation from single power source

ELM852xA is designed to be most suitable for single power source; therefore, ELM852xA is able to share power supply with logic circuit one. Meanwhile, ELM852xA can also operate from double power sources. To protect power supplies of ELM852xA and logic circuit from noise, please separate wire from power supply and use decoupling (bypass) capacitor. Using the capacitor can improve PSRR characteristics, especially on 10kHz to 100kHz or more.

3) Feedback

When OP-AMP circuit is used with feedback resistor, oscillation may happen in the circuit with loop-gain like unity gain follower.

a) When large feedback resistance is used, the phase margin is decreased by its combination with the parasitic capacitance of the input part of OP-AMP. In this situation, please connect small capacitor in parallel with feedback resistor as shown in fig-1.

b) For capacitive load, external resistor in series connection will be effective as shown in fig-2.

($R_L = 300$ to 500Ω)

c) Being used as an unity gain follow, ELM852xA is able to drive capacitive load of 100pF directly without oscillation.

a) fig-1

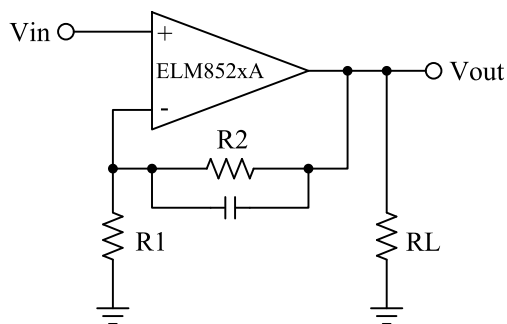

b) fig-2

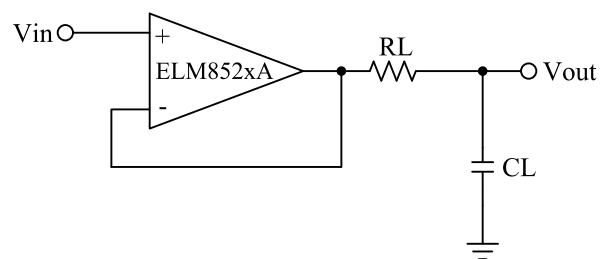

ELM852xA 150 μ A Low power CMOS operational amplifier

<http://www.elm-tech.com>

■ Typical characteristics

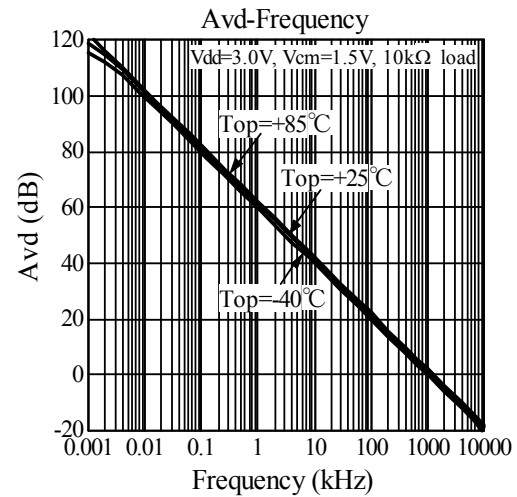
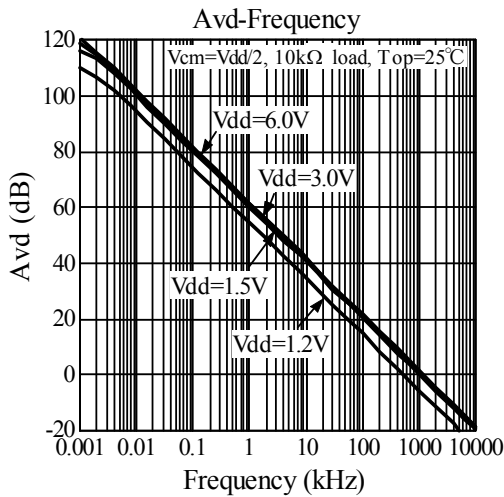
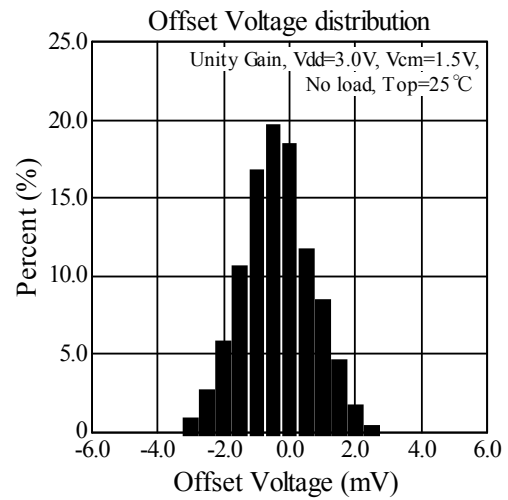
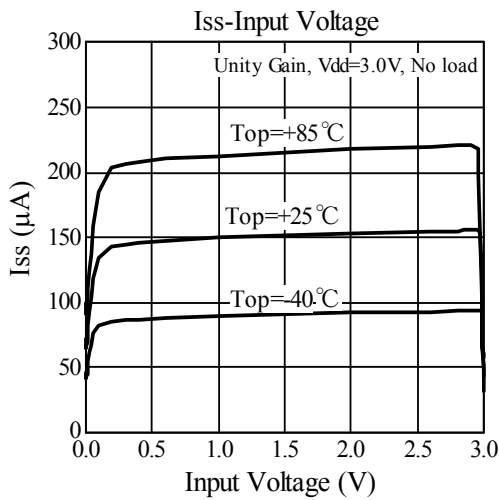
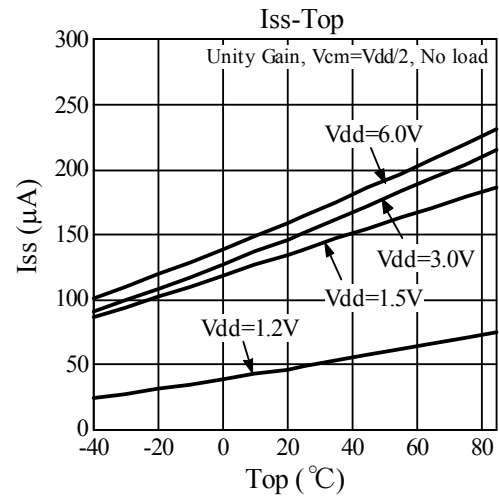
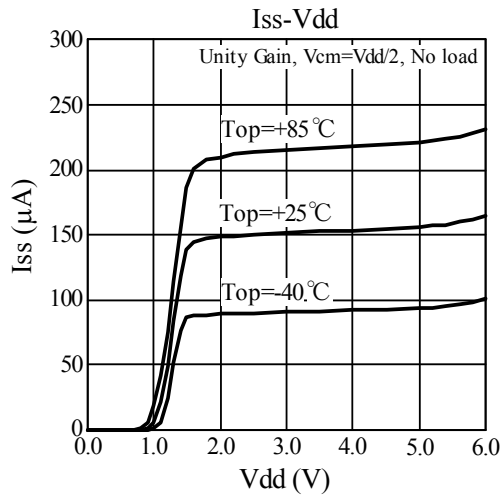

ELM852xA 150µA Low power CMOS operational amplifier

<http://www.elm-tech.com>

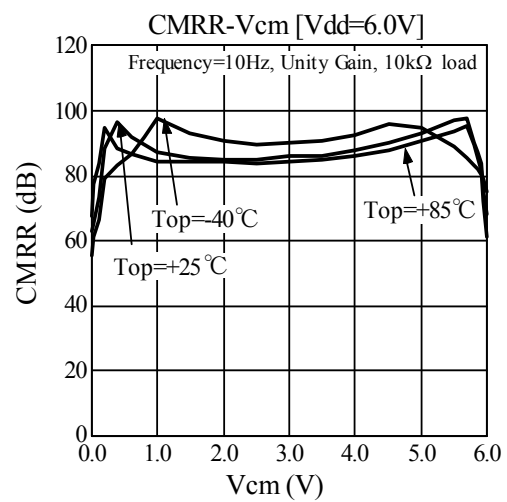
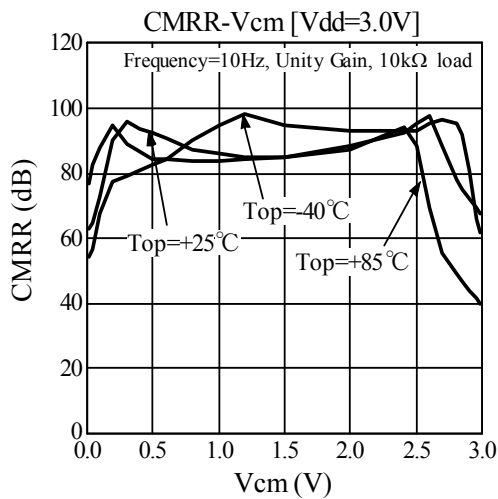
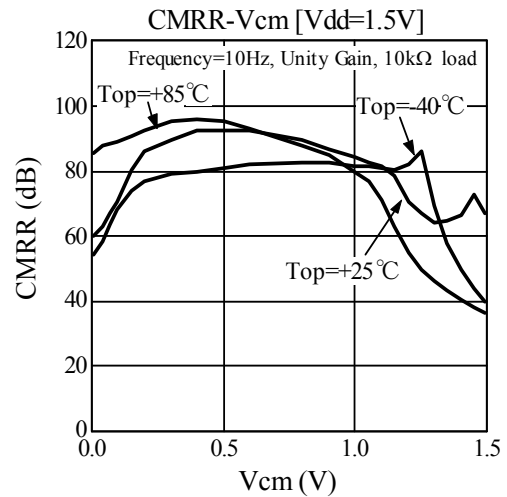
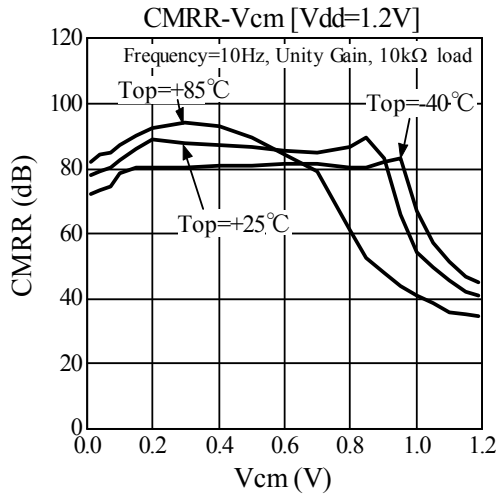
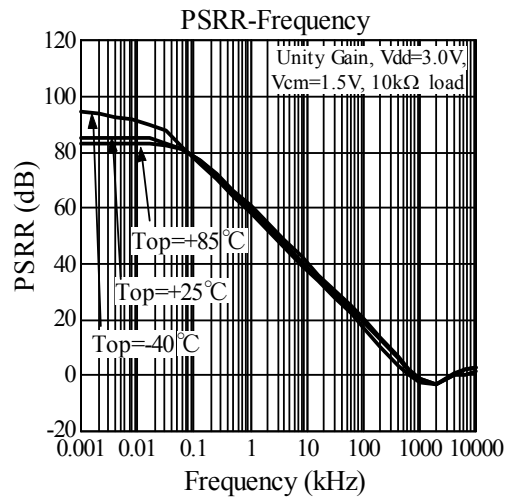
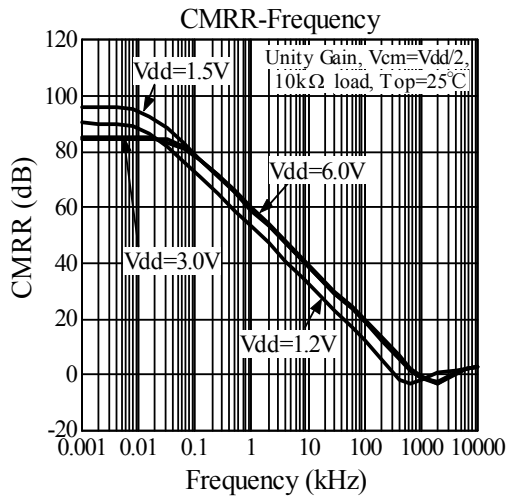

ELM852xA 150 μ A Low power CMOS operational amplifier

<http://www.elm-tech.com>

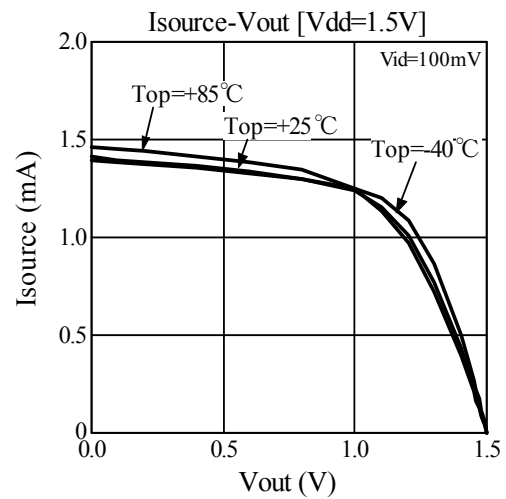
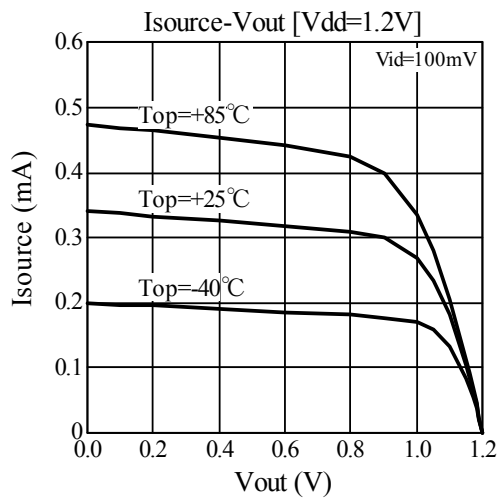
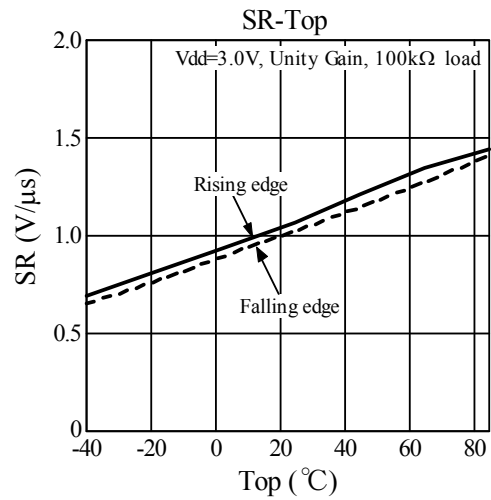
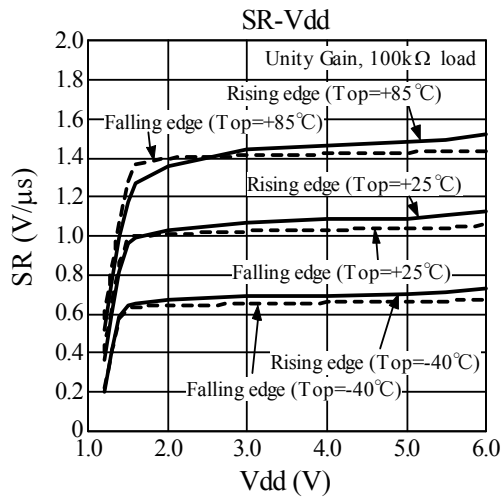
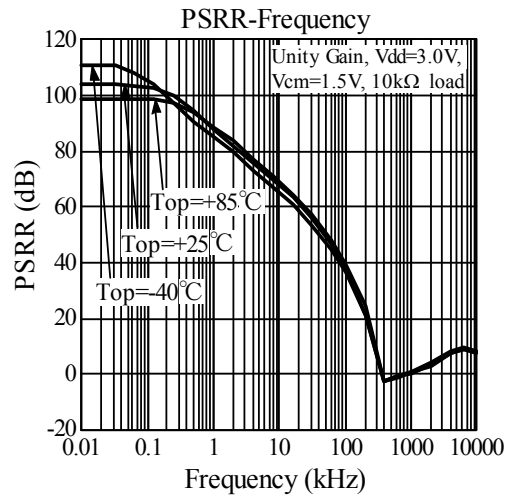
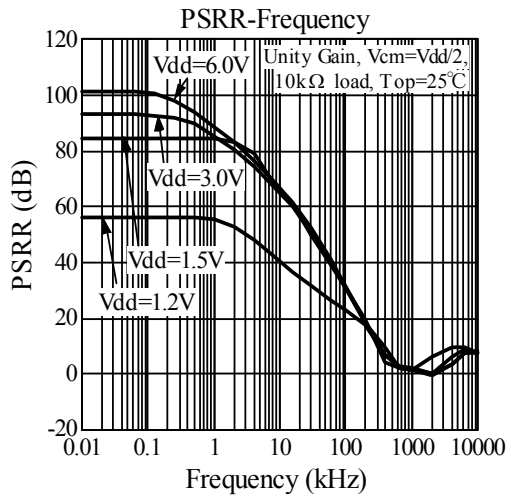

ELM852xA 150 μ A Low power CMOS operational amplifier

<http://www.elm-tech.com>

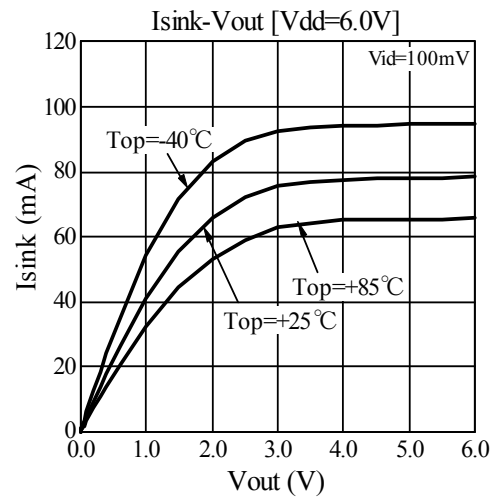
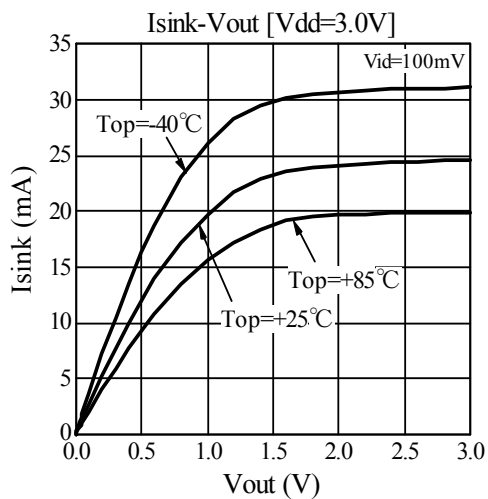
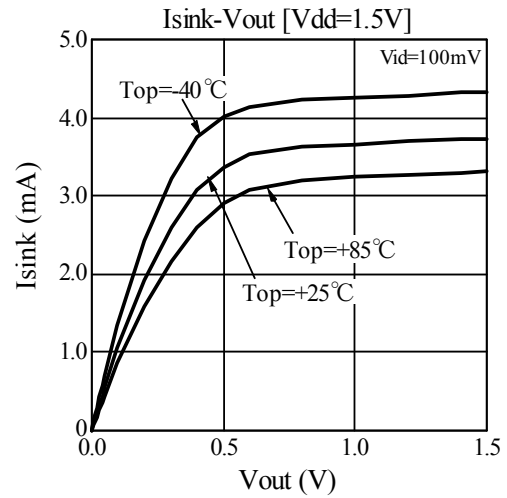
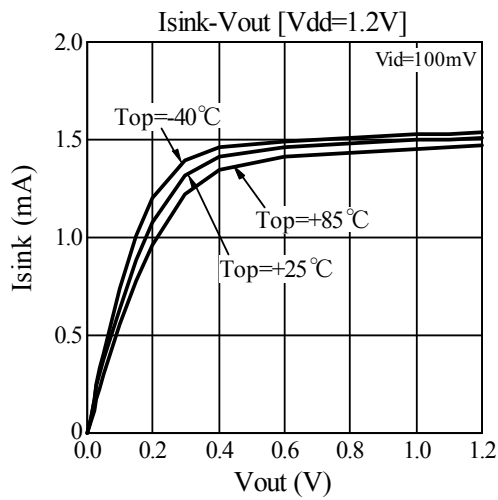
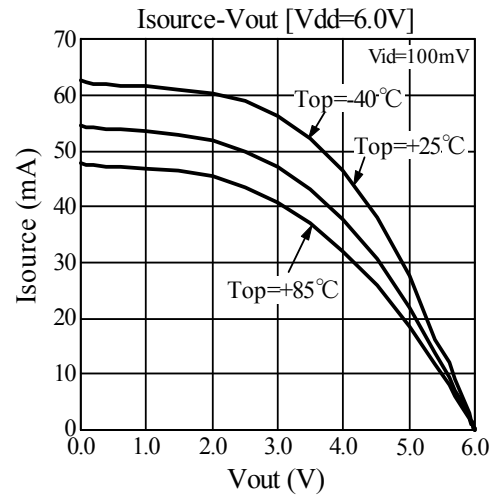
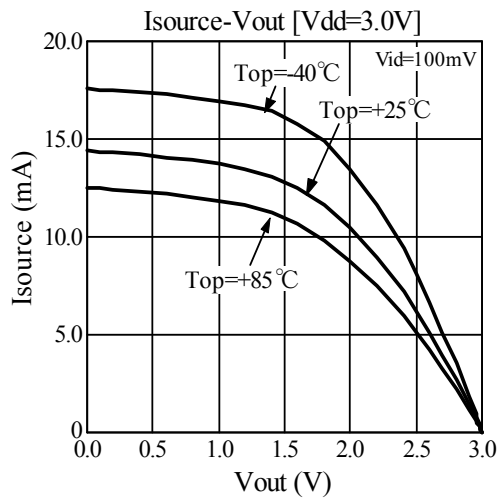

ELM852xA 150 μ A Low power CMOS operational amplifier

<http://www.elm-tech.com>

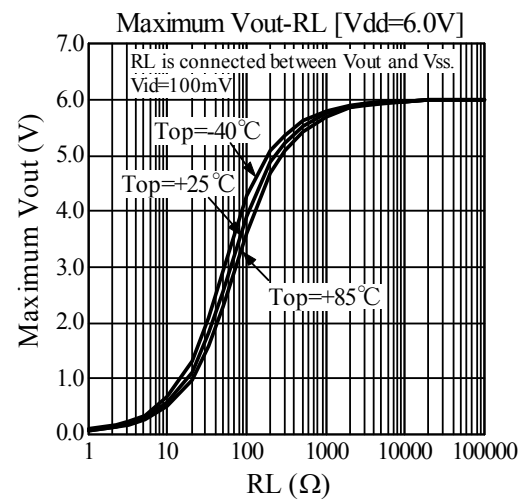
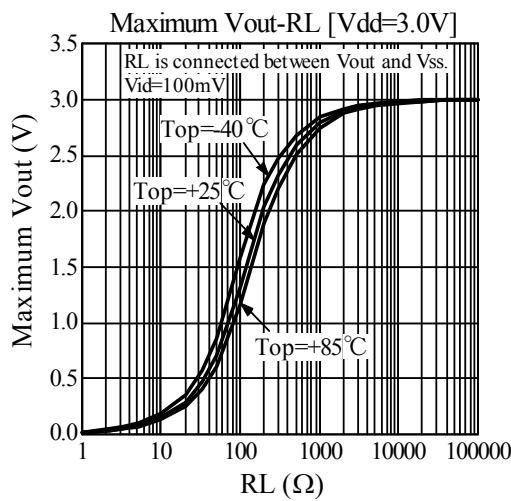
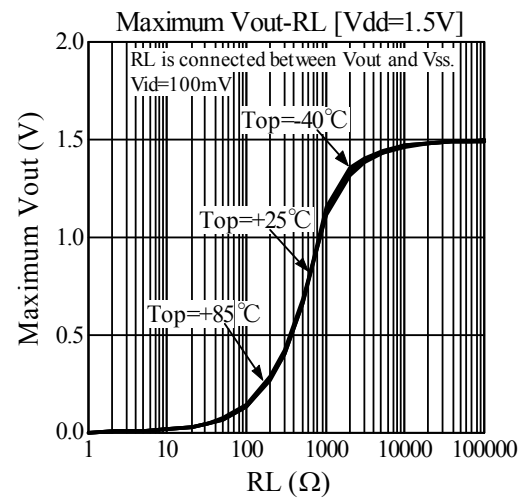
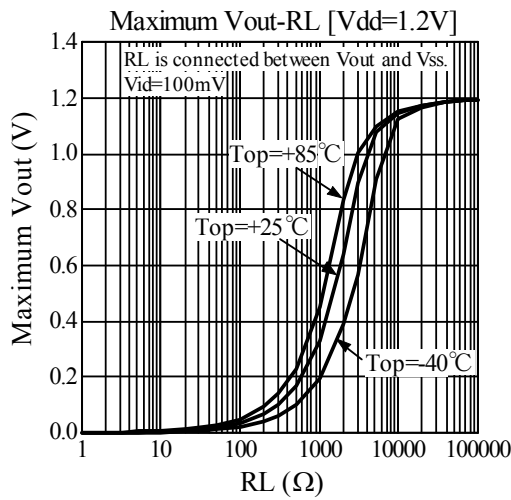
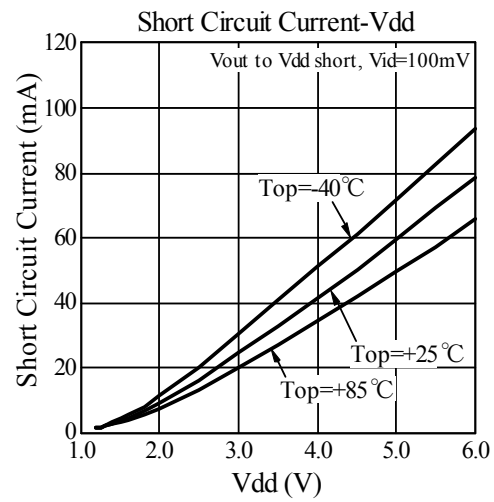
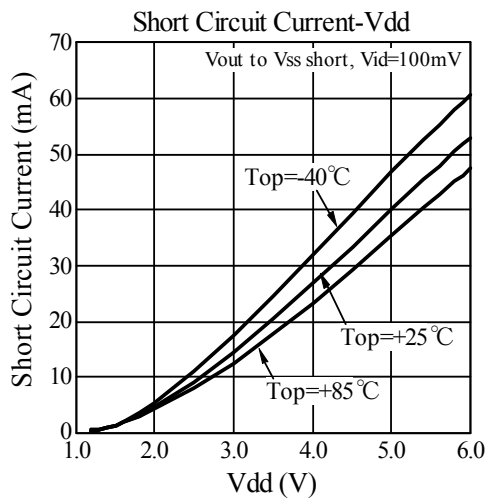

ELM852xA 150 μ A Low power CMOS operational amplifier

<http://www.elm-tech.com>

