

单 N 沟道 MOSFET

ELM4N6004FDA-N

<http://www.elm-tech.com>

■概要

ELM4N6004FDA-N 是 N 沟道低输入电容，低工作电压，低导通电阻的大电流 MOSFET。

■特点

- $V_{ds}=60V$
- $I_d=23A$ ($V_{gs}=10V$)
- $R_{ds(on)} = 30m\Omega$ ($V_{gs}=10V$)
- $R_{ds(on)} = 38m\Omega$ ($V_{gs}=4.5V$)

■绝对最大额定值

如没有特别注明时, $T_c=25^\circ C$

项目	记号	规格范围	单位	备注	
漏极 - 源极电压	V_{ds}	60	V		
栅极 - 源极电压	V_{gs}	± 20	V		
漏极电流 (定常)	I_d	$T_c=25^\circ C$	23.0	A	1
		$T_c=100^\circ C$	15.0		
		$T_a=25^\circ C$	5.6		
		$T_a=70^\circ C$	4.5		
漏极电流 (脉冲)	I_{dm}	46	A	2	
单脉冲崩溃能量	E_{as}	25.5	mJ	3	
崩溃电流	I_{as}	22.6	A		
容许功耗	P_d	$T_c=25^\circ C$	34.7	W	4
		$T_a=25^\circ C$	2.0		
结合部温度及保存温度范围	T_j, T_{stg}	$-55 \sim +150$	$^\circ C$		

■热特性

项目	记号	典型值	最大值	单位	备注
最大结合部 - 环境热阻	$R_{\theta ja}$	-	62.0	$^\circ C/W$	1
接合部 - 外封装热阻	$R_{\theta jc}$	-	3.6	$^\circ C/W$	1

■引脚配置图

TO-252(俯视图)

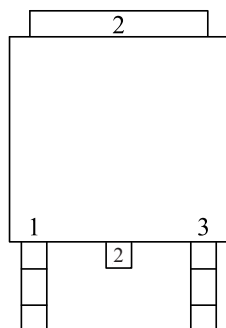

引脚编号	引脚名称
1	GATE
2	DRAIN
3	SOURCE

■电路图

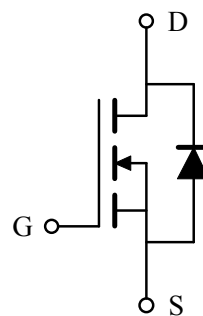

单 N 沟道 MOSFET

ELM4N6004FDA-N

<http://www.elm-tech.com>

■电特性

如没有特别注明时, T_j=25℃

项目	记号	条件	最小值	典型值	最大值	单位	备注
静态特性							
漏极 - 源极击穿电压	BV _{dss}	I _d =250μA, V _{gs} =0V	60	-	-	V	
栅极接地时漏极电流	I _{dss}	V _{ds} =48V, V _{gs} =0V	-	-	1	μA	
		V _{ds} =48V, V _{gs} =0V, T _j =55℃	-	-	5		
栅极漏电流	I _{gss}	V _{ds} =0V, V _{gs} =±20V	-	-	±100	nA	
栅极阈值电压	V _{gs(th)}	V _{ds} =V _{gs} , I _d =250μA	1.2	-	2.5	V	
漏极 - 源极导通电阻	R _{dson}	V _{gs} =10V, I _d =15A	-	25	30	mΩ	2
		V _{gs} =4.5V, I _d =10A	-	30	38		
正向跨导	G _{fs}	V _{ds} =5V, I _d =15A	-	17		S	
二极管正向压降	V _{sd}	I _s =1A, V _{gs} =0V	-	-	1.2	V	2
寄生二极管最大连续电流	I _s	V _{gs} =V _{ds} =0V, Force current	-	-	23	A	1, 5
二极管脉冲电流	I _{sm}		-	-	46	A	2, 5
动态特性							
输入电容	C _{iss}	V _{gs} =0V, V _{ds} =15V, f=1MHz	-	1378	-	pF	
输出电容	C _{oss}		-	86	-	pF	
反馈电容	C _{rss}		-	64	-	pF	
栅极电阻	R _g	V _{gs} =0V, V _{ds} =0V, f=1MHz	-	3.2	-	Ω	
开关特性							
总栅极电荷 (4.5)	Q _g	V _{gs} =4.5V, V _{ds} =48V, I _d =12A	-	12.6	-	nC	
栅极 - 源极电荷	Q _{gs}		-	3.2	-	nC	
栅极 - 漏极电荷	Q _{gd}		-	6.3	-	nC	
导通延迟时间	t _{d(on)}	V _{gs} =10V, V _{ds} =30V, I _d =10A R _{gen} =3.3Ω	-	8.0	-	ns	
导通上升时间	t _r		-	14.2	-	ns	
关闭延迟时间	t _{d(off)}		-	24.4	-	ns	
关闭下降时间	t _f		-	4.6	-	ns	

备注:

1. 安装在70μm厚铜箔的1平方英寸FR-4上时的值;
2. 脉冲测试: 脉冲宽度≤300μ秒和占空比≤2%;
3. E_{as}表示的是最大值。测试条件为V_{dd}=25V, V_{gs}=10V, L=0.1mH, I_{as}=22.6A;
4. 功耗受150℃结合部温度限制;
5. 在理论上数据是与I_d和I_{dm}相同的, 而在实际应用中是受到总功率损耗限制的。

单 N 沟道 MOSFET

ELM4N6004FDA-N

<http://www.elm-tech.com>

■ 标准特性和热特性曲线

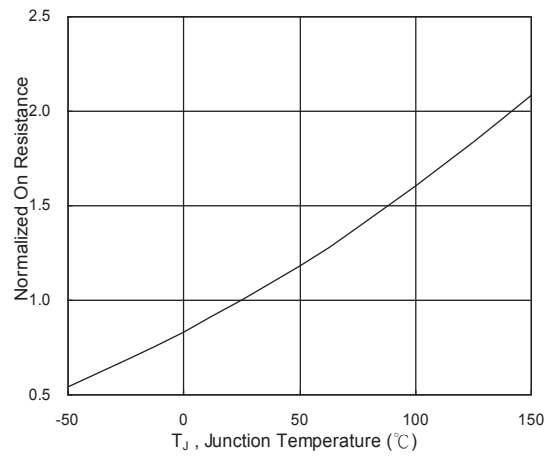
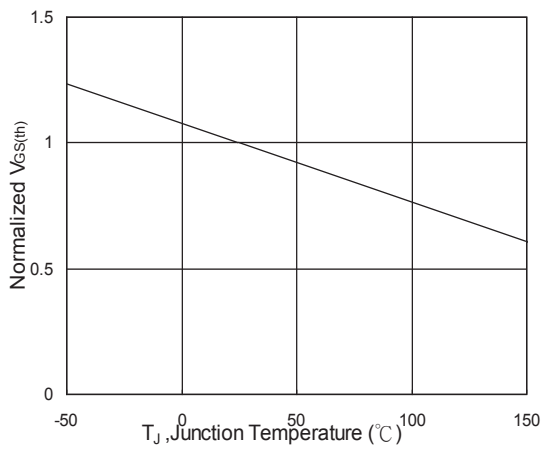
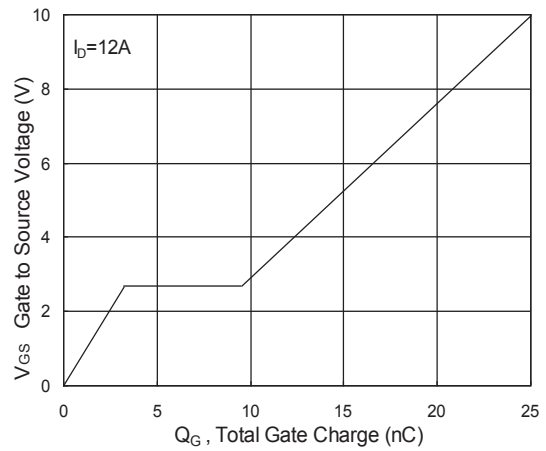
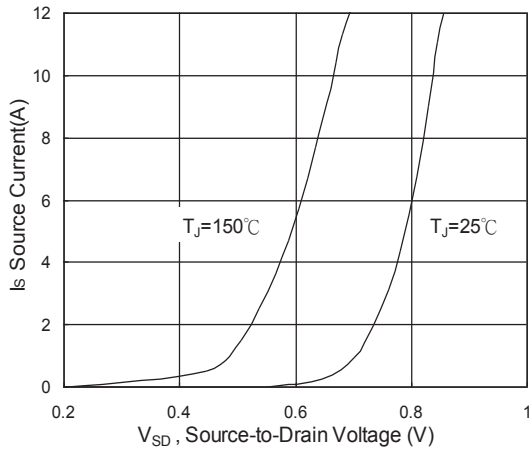
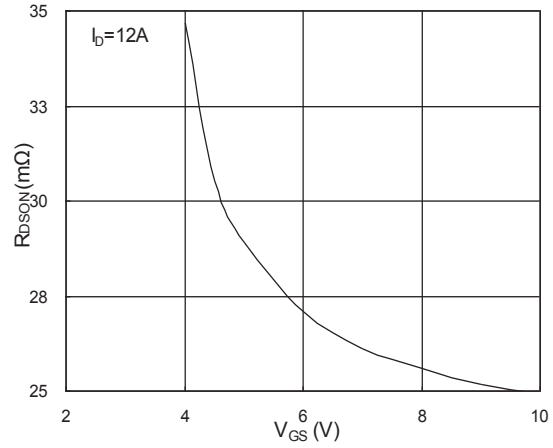
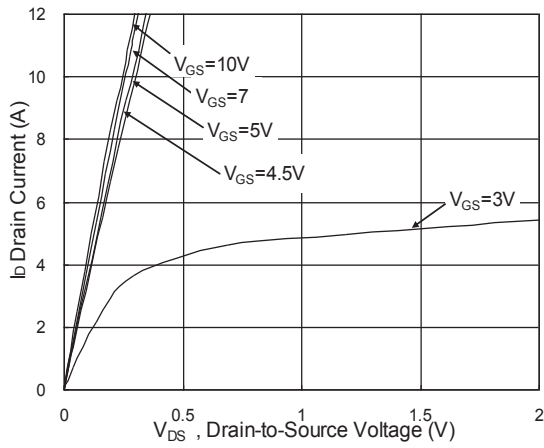

单 N 沟道 MOSFET

ELM4N6004FDA-N

<http://www.elm-tech.com>

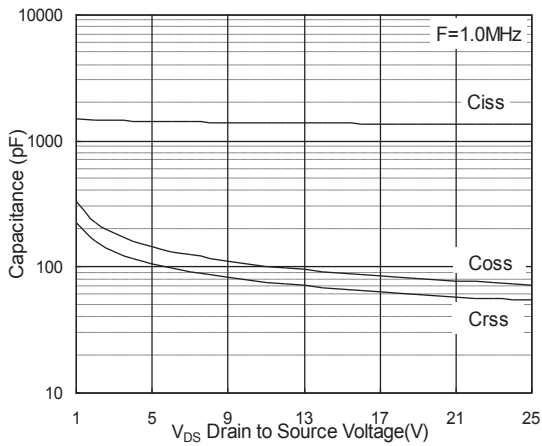

Fig.7 Capacitance

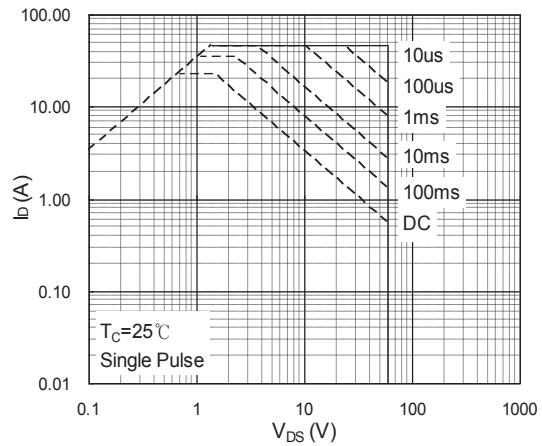

Fig.8 Safe Operating Area

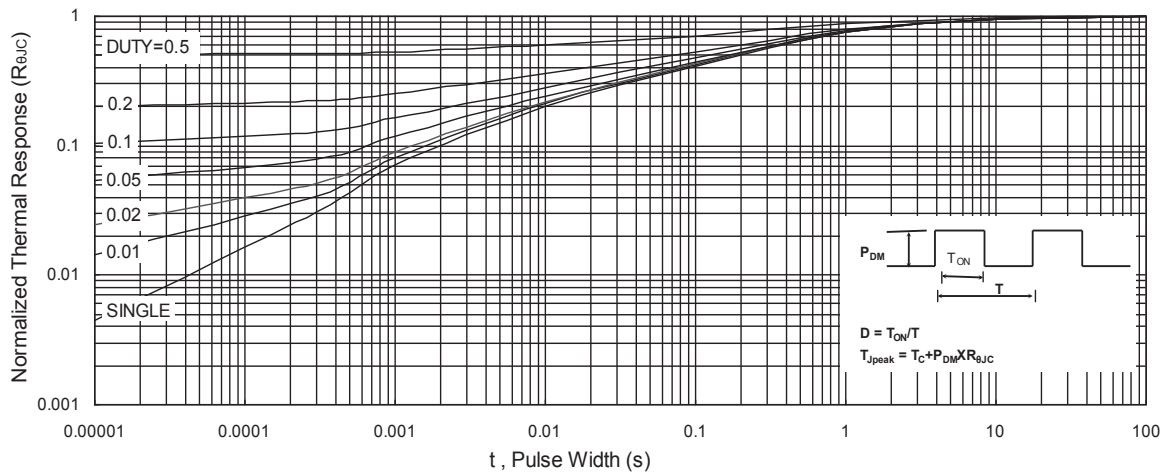

Fig.9 Normalized Maximum Transient Thermal Impedance

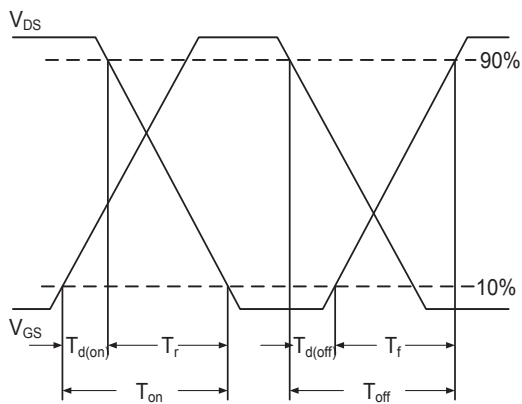

Fig.10 Switching Time Waveform

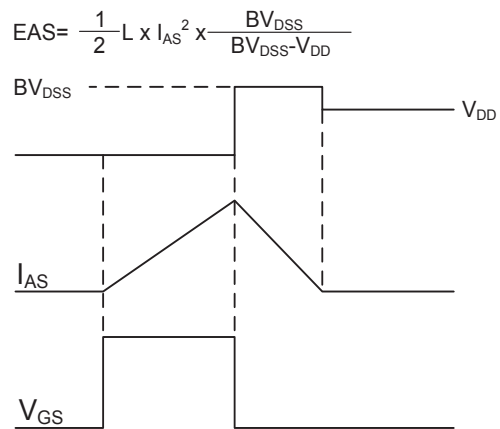

Fig.11 Unclamped Inductive Waveform