

# 单 P 沟道 MOSFET

ELM58463A-S

<http://www.elm-tech.com>

## ■概要

ELM58463A-S 是 P 沟道低输入电容,低工作电压,低导通电阻的大电流 MOSFET。

## ■特点

- $V_{ds} = -40V$
- $I_d = -6.0A$
- $R_{ds(on)} = 46m\Omega$  ( $V_{gs} = -10V$ )
- $R_{ds(on)} = 62m\Omega$  ( $V_{gs} = -4.5V$ )

## ■绝对最大额定值

如没有特别注明时,  $T_a = 25^\circ C$

项目	记号	规格范围	单位	
漏极 - 源极电压	$V_{ds}$	-40	V	
栅极 - 源极电压	$V_{gs}$	$\pm 20$	V	
漏极电流 (定常) $T_j = 150^\circ C$	Id	$T_a = 25^\circ C$	-6.0	A
		$T_a = 70^\circ C$	-4.2	
漏极电流 (脉冲)	$I_{dm}$	-10	A	
容许功耗	Pd	$T_c = 25^\circ C$	2.8	W
		$T_c = 70^\circ C$	1.2	
动作结合部温度	$T_j$	150	$^\circ C$	
保存温度范围	$T_{stg}$	-55 ~ 150	$^\circ C$	

## ■热特性

项目	记号	典型值	最大值	单位
最大结合部 - 环境热阻	$R_{\theta ja}$		120	$^\circ C/W$

## ■引脚配置图

SOT-223(俯视图)

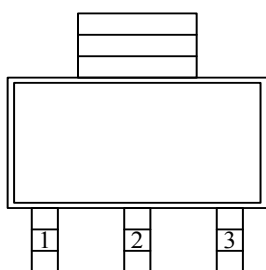

引脚编号	引脚名称
1	GATE
2	DRAIN
3	SOURCE

## ■电路图

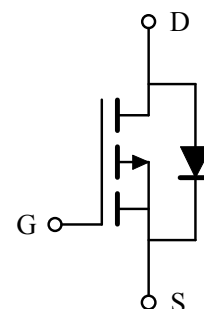

# 单 P 沟道 MOSFET

ELM58463A-S

<http://www.elm-tech.com>

## ■电特性

如没有特别注明时,  $T_a=25^\circ\text{C}$

项目	记号	条件	最小值	典型值	最大值	单位
静态特性						
漏极 - 源极击穿电压	BV <sub>dss</sub>	$I_d=-250\mu\text{A}, V_{gs}=0\text{V}$	-40			V
栅极接地时漏极电流	I <sub>dss</sub>	$V_{ds}=-40\text{V}$ $V_{gs}=0\text{V}$			-1	$\mu\text{A}$
		$T_a=85^\circ\text{C}$			-20	
栅极漏电流	I <sub>gss</sub>	$V_{ds}=0\text{V}, V_{gs}=\pm 20\text{V}$			$\pm 100$	nA
栅极阈值电压	V <sub>gs(th)</sub>	$V_{ds}=V_{gs}, I_d=-250\mu\text{A}$	-1.0		-3.0	V
导通时漏极电流	I <sub>d(on)</sub>	$V_{gs}=-10\text{V}, V_{ds}\geq -5\text{V}$	-20			A
漏极 - 源极导通电阻	R <sub>ds(on)</sub>	$V_{gs}=-10\text{V}, I_d=-6.0\text{A}$		40	46	m $\Omega$
		$V_{gs}=-4.5\text{V}, I_d=-4.2\text{A}$		55	62	
正向跨导	G <sub>fs</sub>	$V_{ds}=-15\text{V}, I_d=-5\text{A}$		20		S
二极管正向压降	V <sub>sd</sub>	$I_s=-2.0\text{A}, V_{gs}=0\text{V}$		-0.8	-1.2	V
寄生二极管最大连续电流	I <sub>s</sub>				-1.6	A
动态特性						
输入电容	C <sub>iss</sub>	$V_{gs}=0\text{V}, V_{ds}=-20\text{V}, f=1\text{MHz}$		1100		pF
输出电容	C <sub>oss</sub>			145		pF
反馈电容	C <sub>rss</sub>			115		pF
开关特性						
总栅极电荷	Q <sub>g</sub>	$V_{gs}=-4.5\text{V}, V_{ds}=-20\text{V}$ $I_d\equiv -3.0\text{A}$		13.0	20.0	nC
栅极 - 源极电荷	Q <sub>gs</sub>			4.5		nC
栅极 - 漏极电荷	Q <sub>gd</sub>			6.5		nC
导通延迟时间	t <sub>d(on)</sub>	$V_{gs}=-4.5\text{V}, V_{ds}=-20\text{V}$ $R_L=4\Omega, I_d\equiv -3.0\text{A}$ $R_{gen}=1.0\Omega$		40	80	ns
导通上升时间	t <sub>r</sub>			55	100	ns
关闭延迟时间	t <sub>d(off)</sub>			30	60	ns
关闭下降时间	t <sub>f</sub>			12	20	ns

# 单 P 沟道 MOSFET

ELM58463A-S

<http://www.elm-tech.com>

## 标准特性和热特性曲线

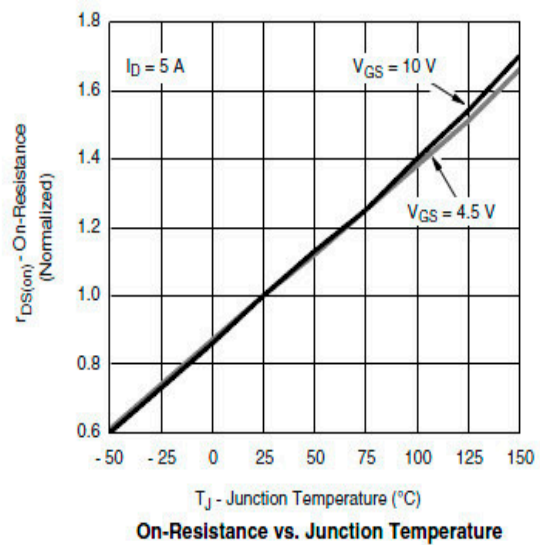
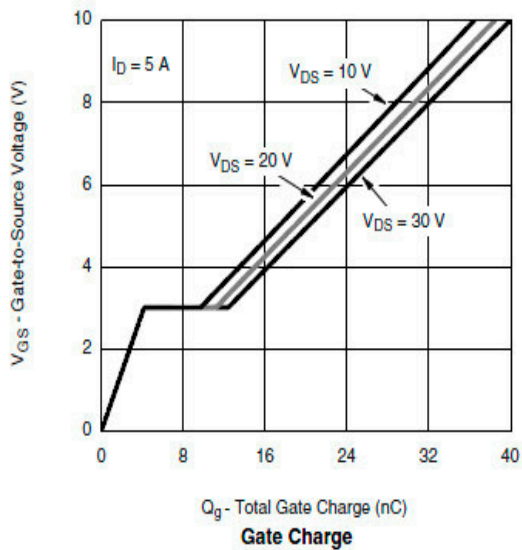
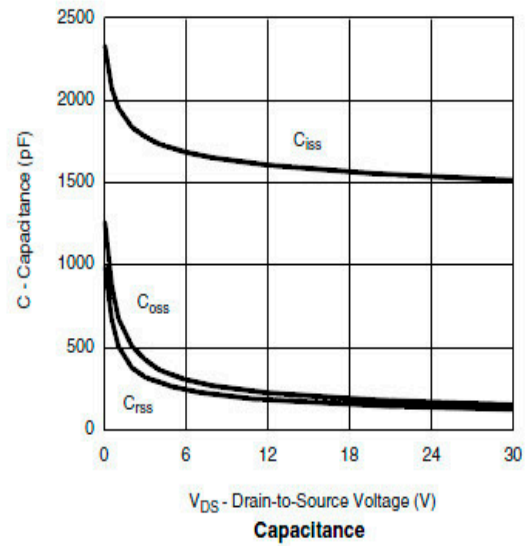
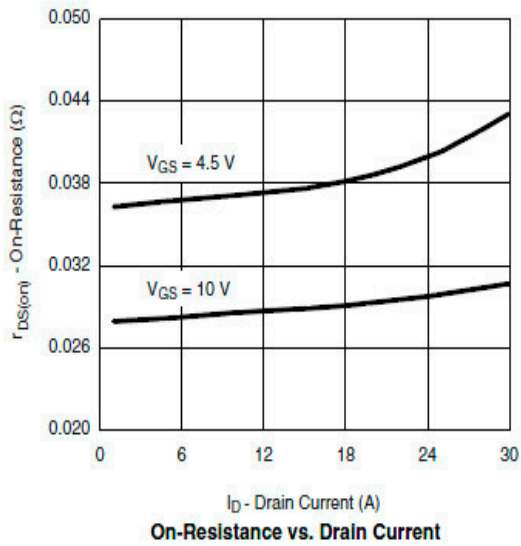
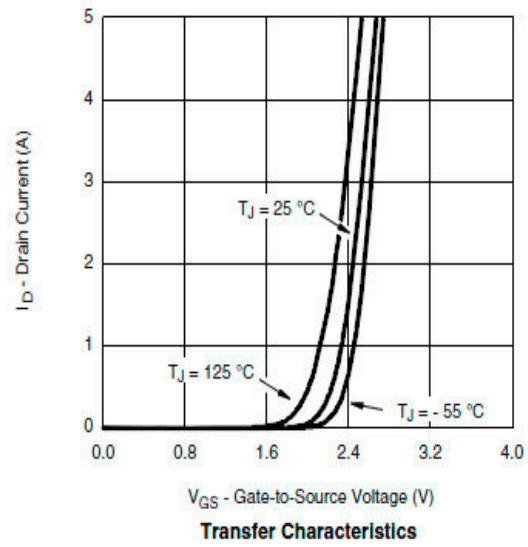
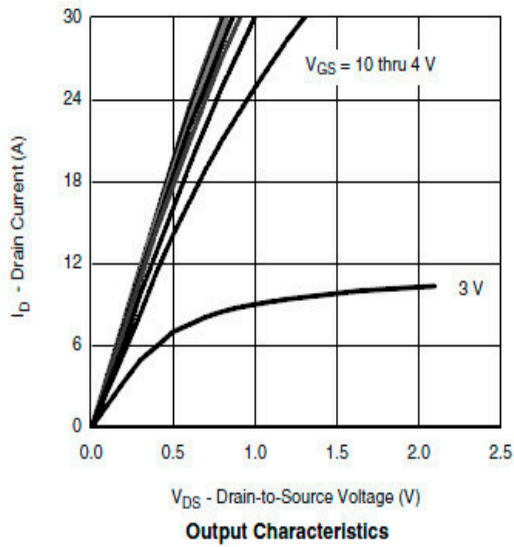

# 单 P 沟道 MOSFET

ELM58463A-S

<http://www.elm-tech.com>

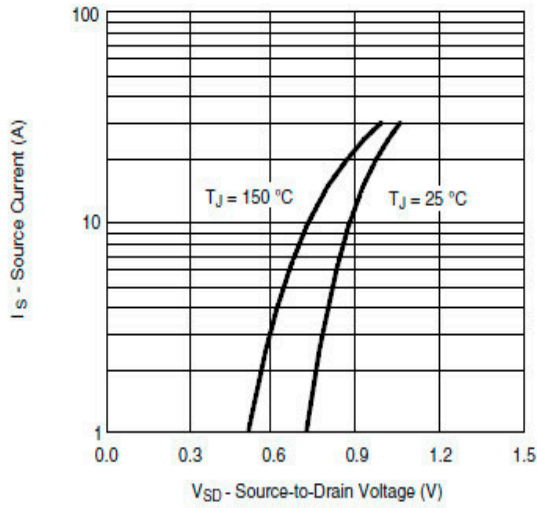

Source-Drain Diode Forward Voltage

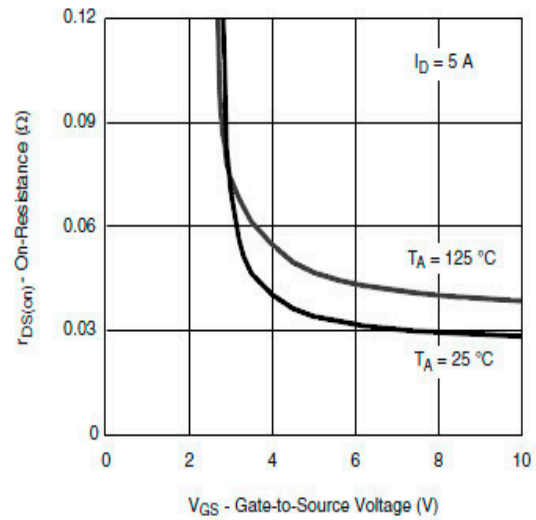

On-Resistance vs. Gate-to-Source Voltage

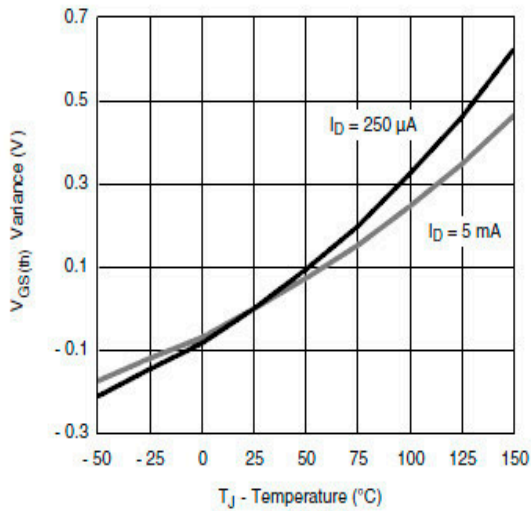

Threshold Voltage

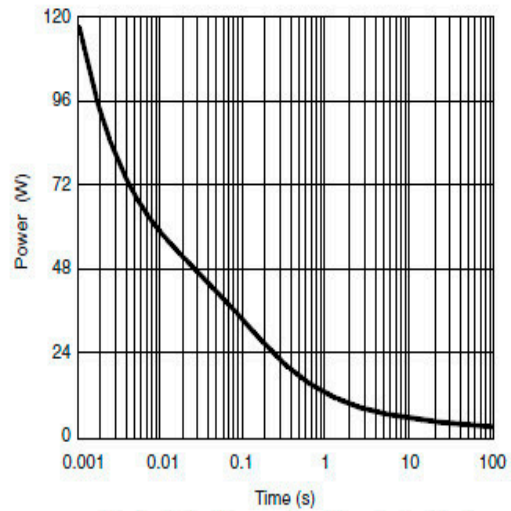

Single Pulse Power, Junction-to-Ambient

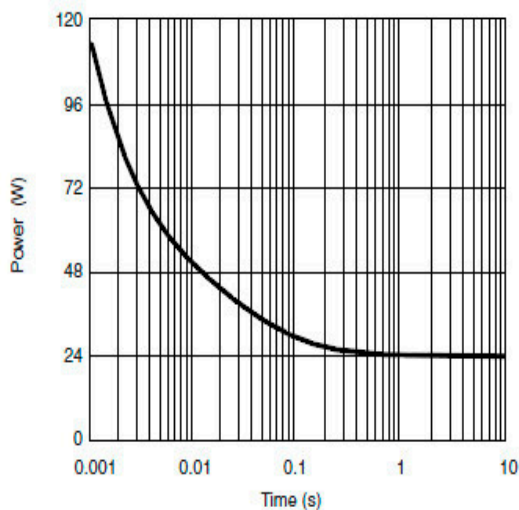

Single Pulse Power, Junction-to-Case

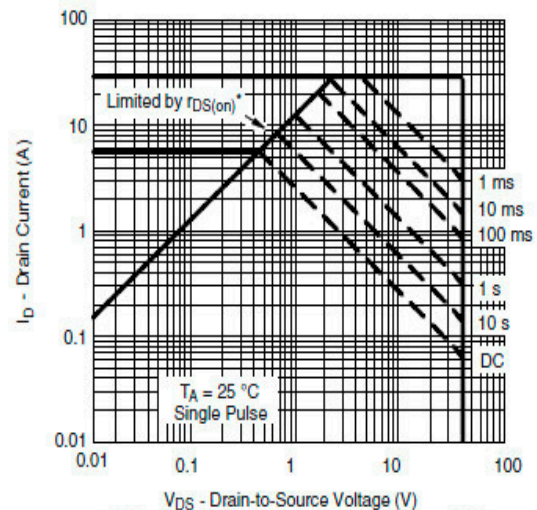

Safe Operating Area, Junction-to-Ambient

# 单 P 沟道 MOSFET

ELM58463A-S

<http://www.elm-tech.com>

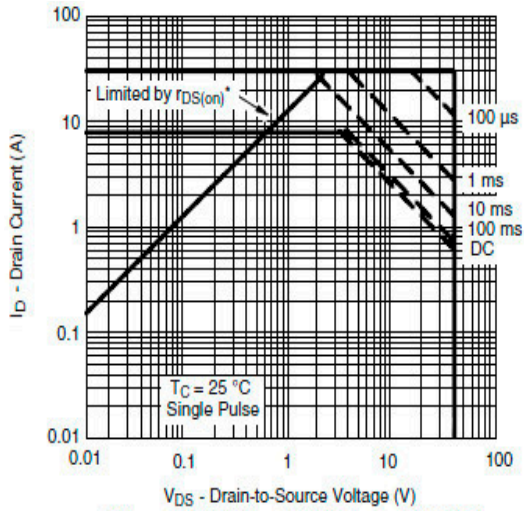

\*  $V_{GS} >$  minimum  $V_{GS}$  at which  $r_{DS(on)}$  is specified  
**Safe Operating Area, Junction-to-Case**

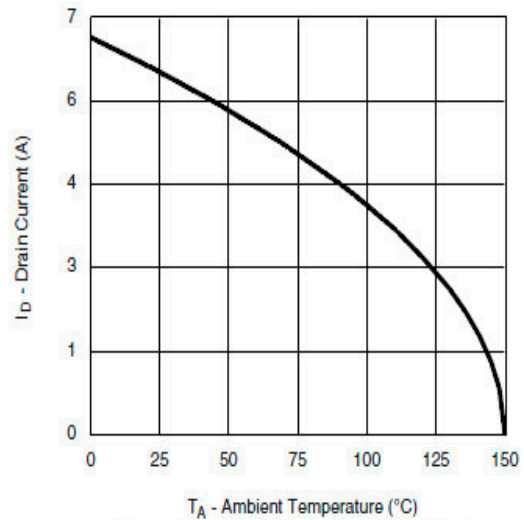

**Current Derating\*, Junction-to-Ambient**

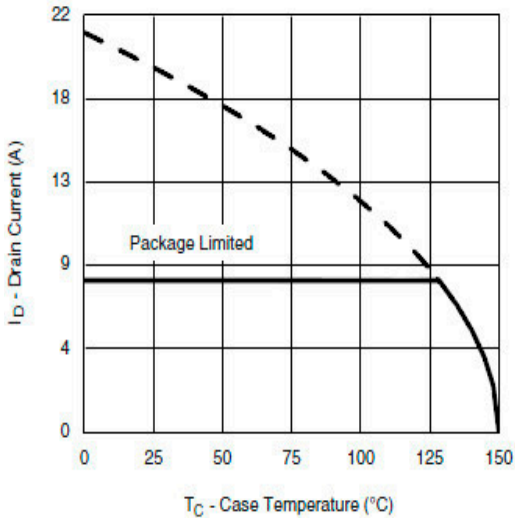

**Current Derating\*, Junction-to-Case**

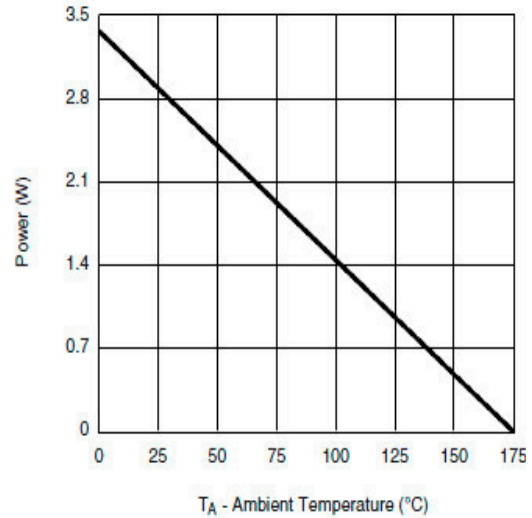

**Power Derating\*, Junction-to-Ambient**

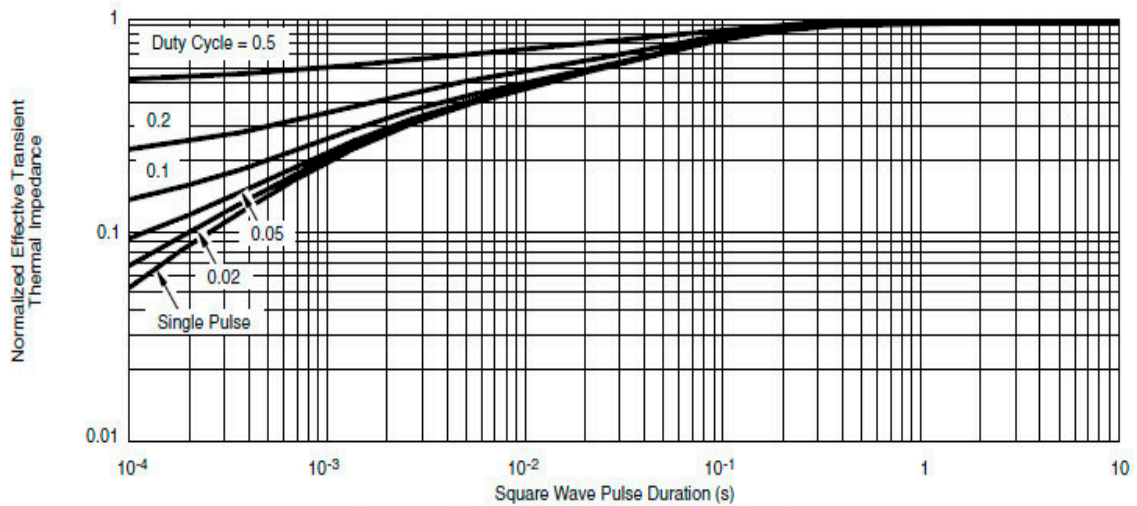

**Normalized Thermal Transient Impedance, Junction-to-Case**



# 单 P 沟道 MOSFET

ELM58463A-S

<http://www.elm-tech.com>

## 测试电路和波形

### Gate Charge Test Circuit & Waveform

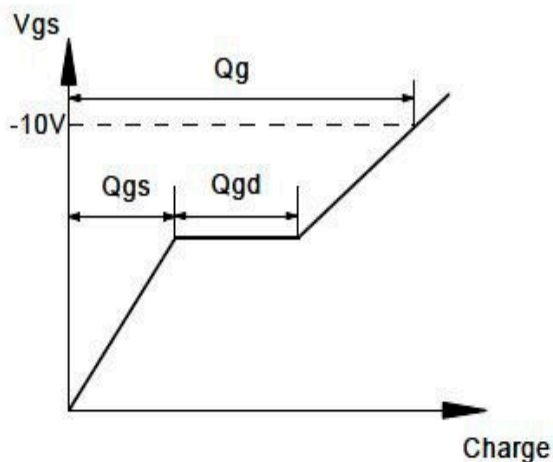
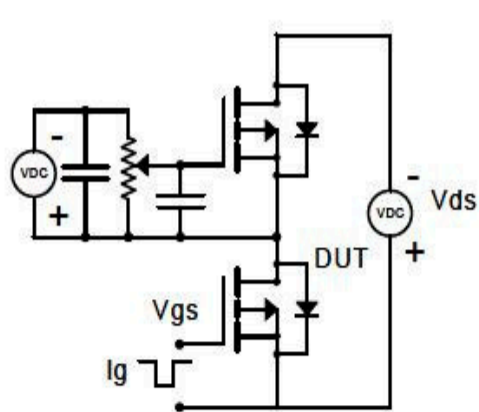

### Resistive Switching Test Circuit & Waveforms

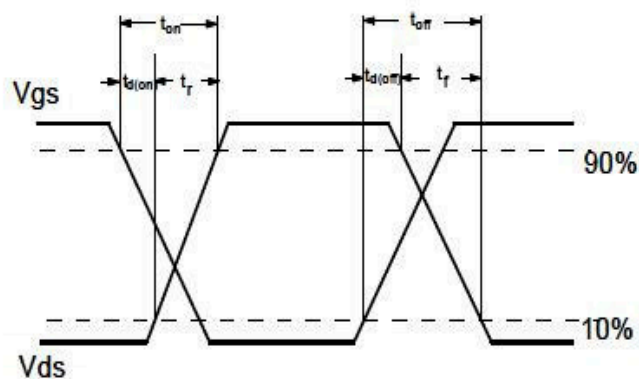
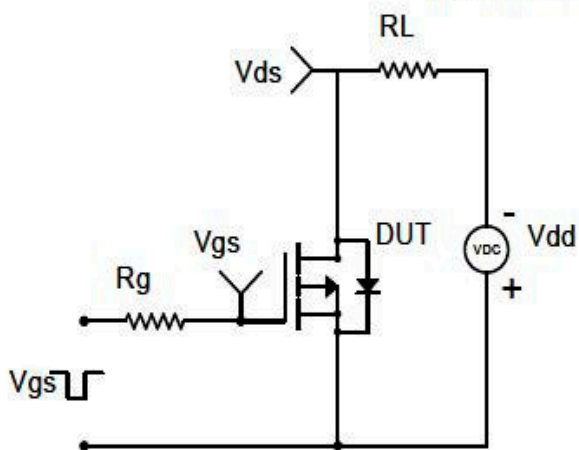

### Diode Recovery Test Circuit & Waveforms

